

HALFEN FLEXIBLE BOLT CONNECTIONS

TECHNICAL PRODUCT INFORMATION



HALFEN FLEXIBLE BOLT CONNECTIONS

MT-FBC 14.1-E

FRAMING SYSTEMS

NEW!

- CE-marking EN 1090-1, EN 1090-2 for all hot-rolled framing channels
- Supplementary load capacities according to Eurocode 3
- Addition of framing channels HM 55/42, HZM 64/44, HZM 41/27



HALFEN
YOUR BEST CONNECTIONS

HALFEN FRAMING SYSTEMS

Contents



HALFEN Framing Systems

- European standards EN 1090 / EN 1993	4
- General overview	5



Framing channels

- Introduction – HALFEN Framing channels and HALFEN Bolts	6-7
- Bolt length selection, locking plates, order examples	8
- Framing channels – The advantages at a glance	9
- Materials, finishes, coatings	10-11
- Product range – overview framing channels and bolts	12-13

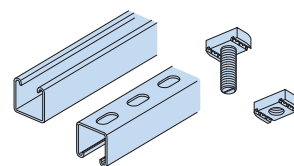

Framing channels - heavy duty framing system

- Profile HM 72/48	14
- HALFEN Bolt HS 72/48	15
- Profiles HM 55/42, HM 52/34	16-17
- Profiles HM 50/30, HM 49/30, HM 50/40, HM 486	18-20
- HALFEN Bolts HS 50/30, HSR 50/30	21
- Locking plates GWP 50/30, GWP 50/40	22
- Profiles HM 40/22, HM 40/25, HM 422	23-24
- HALFEN Bolts and locking plates HS 40/22, HSR 40/22, GWP 40/22	25
- Serrated profile HZM 64/44	26
- Serrated HALFEN Bolt HZS 64/44	27
- Serrated profile HZM 53/34	28
- Serrated HALFEN Bolt HZS 53/34	29
- Serrated profiles HZM 41/27, HZM 38/23	30-31
- HALFEN Bolts HZS 38/23, HS 38/17	32
- Serrated profile HZM 29/20	33
- HALFEN Bolts HZS 29/20, HS 28/15	34

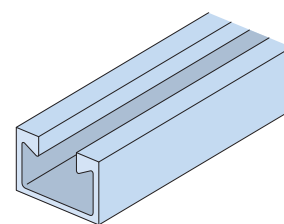

Framing channels - medium duty framing system

- Profiles HM 41/41, HL 41/41	35
- Serrated profiles HZM 41/41, HZL 41/41	36
- Profiles HM 41/62, HL 41/62, HM 41/83, HL 41/83	37-38
- Powerclick standard profile HZL 63/63	39
- Profiles HM 41/22, HL 41/22	40
- Serrated profiles HZM 41/22, HZL 41/22	41

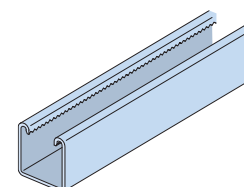

HALFEN FRAMING SYSTEMS

Contents

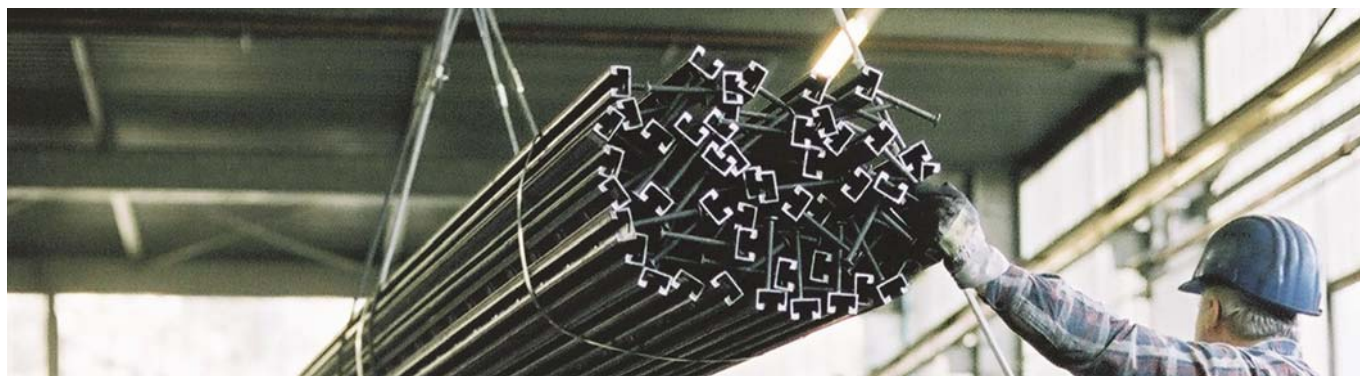

-	Profiles HLL 41/41, HLL 41/22	42
-	HALFEN Bolts HZS 41/41, HZS 41/22, HS 41/41	43
-	Locking plates GWP 41/... and locking plates with spring	44

Framing channels - light duty framing systems

-	Profiles HM 36/36, HL 36/36, HM 38/17	45
-	HALFEN Bolts and locking plates HS 38/17, GWP 38/17	46
-	Profiles 28/28, 26/26, 28/15, HM 315	47-50
-	HALFEN Bolts and locking plates 28/15	51
-	Profiles and HALFEN Bolts 20/12	52-53

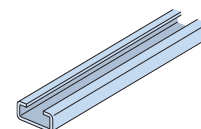

Accessories

-	HALFEN Bolts – overview	54-55
-	Threaded rods, nuts, washers, hexagon head bolts	56-57
-	Channel end caps, channel covers	58
-	Cantilevers – HALFEN Flexible comprehensive support systems	59

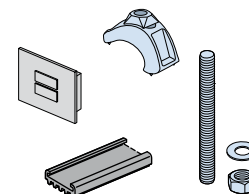

Statics

-	Cross section properties/bending load capacities: hot-rolled channels	60-61
-	Cross section properties/bending load capacities: cold-rolled channels	62-63
-	Cross section properties/bending load capacities: slotted channels	64-65
-	Point-load capacities of welded or bolted channels	66-68
-	Bending moment of HALFEN Bolts	69
-	Flexural buckling – Framing channels as compression elements	70-71

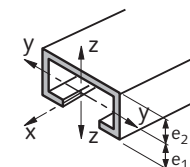

Application in mechanical engineering

-	Design references	72
-	Selecting the correct bolt length	73
-	Channel bolt connection: pre-tension force	75
-	Channel bolt connection: load capacities/design examples	76-78
-	Transfer of dynamic loads	79

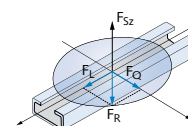

Anhang

-	Tender, examples	80
-	Powerclick System	81
-	Index/contact/technical support	82-83

HALFEN FRAMING SYSTEMS

General Information

European standards EN 1090 / EN 1993

The new EN 1090 series of standards replace the previous DIN 18800-7 standard, regulating execution of steel structures and manufacturing qualifications.

European standard EN 1090-1 specifies requirements for conformity assessment (CE marking) of structural components which will be placed on the European market as construction products.

The conformity assessment covers the manufacturing characteristics and where appropriate the structural design characteristics.

The EN 1090-2 standard regulates the requirements applicable to the execution of steel structures. This standard applies to structures that are verified according to the appropriate section of EN 1993 (EC3).

The phase-out period for DIN 18800-7 ended on the 30th of June 2014.

Basis for the evaluation of conformity of steel construction products is the system of assessment of conformity 2+ according to Construction Products Regulation (CPR) EU No. 305/2011.



EN 1090-1, EN 1090-2
2499 - CPR-0113070-00-01



The CE marking confirms conformity with the declared performance of HALFEN Products and with all relevant European harmonized standards in the European Union.

HALFEN Framing channels are also subject to these regulations. To meet CE evaluation obligations the marked products are statically verified in accordance with EN 1993 and the principal performance characteristics are detailed in the respective Declaration of Performance, CONF-DOP_HM resp. CONF-DOP_HZM.

CE marking is mandatory from the 1st of July 2014 when distributing load bearing metallic construction products in the European market.

HALFEN is certified by the notified Body ZDH-ZERT GmbH. Apart from production, the certification includes the method of calculation required by the HALFEN Engineers and their respective qualifications.

Design method

The European standard EN 1993 was created with the intention to establish uniform, Europe-wide calculation methods for steel structures. However, because these calculation methods have not yet been adopted in all industries we have decided to include two sets of values for load capacities of framing channels and HALFEN Bolts in the following tables.

- working loads will continue to be defined as "allow. F" and
- design values of the resistance will be defined as „F_{Rd}“.

The term "design value" is taken from the current applicable standards, for example EN 1993 (EC3), with new safety concept, and must be strictly differentiated from the term "allowable load". The European standard which is based on the so called "partial safety factors" is applied to material resistance as well as to the action (load). The following verification is required:

$$F_{Ed} \leq F_{Rd}$$

F_{Ed} = calculation value for action
F_{Rd} = design value for resistance

The traditional, deterministic safety concept however is based on the method of using a global safety factor for material resistance and is known as the "allowable load method" resp. "allowable tension method". These methods are used in mechanical and plant engineering. For these cases the allowable values for load capacity are calculated. Verification is as follows:

$$F \leq \text{allow. } F$$

F = load on the structure
allow. F = allowable load

HALFEN FRAMING SYSTEMS

General Information

Adjustable HALFEN Channel fixing systems offer a whole range of benefits:

- The adjustable HALFEN Channel-bolt system is a supporting as well as a fixing system
- Full flexibility in positioning and dimensioning the bolt connections
- Choice of corrosion protection:
 - Strip galvanized framing channels for low demands
 - Hot-dip galvanized framing channels for high demands
 - Framing channels in stainless steel for maximum requirements
- Quick assembly and adjustment of equipment and structural components
- Change or up-date entire projects with standard tools
- No specialist required to carry out modifications on site
- Dust free and low noise levels when modification work is done on site
- Corrosion protection is not compromised by bolting
- A large selection of standard channels with good load bearing characteristics

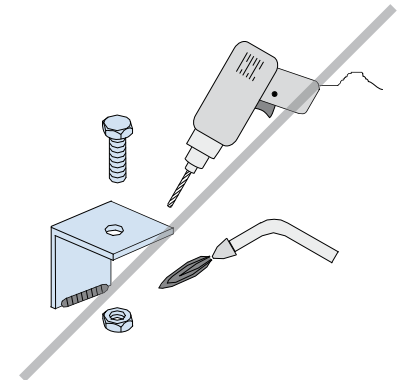
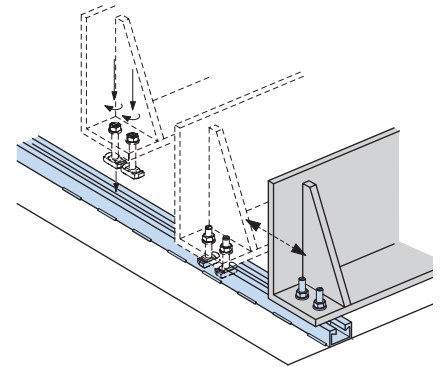

With HALFEN Framing channels you avoid:

- Time consuming planning of inflexible bolted fixings
- Costly manufacturing of bolt fixings
- Costly corrosion protection work when upgrading already completed structural components i.e. when adjusting components to site

HALFEN Channels

All hot-rolled HALFEN Profiles and some of the light framing channels are also available as **HALFEN HTA/HZA Cast-in channels**. Both versions use the same bolts and locking plates.

You can find more information on HALFEN Channels in our Technical Product Information "**HALFEN Cast-in channels**".

[www.halfen.com/
Products/Fixing systems/
HTA-Cast-in channels](http://www.halfen.com/Products/Fixing%20systems/HTA-Cast-in%20channels)

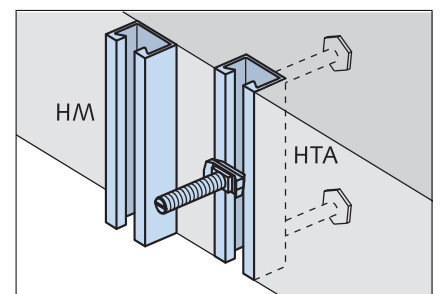

Quality

Quality is an outstanding feature of our products. HALFEN materials and products are subject to stringent quality controls.

A quality audit by the DNV GL confirmed that our quality management system meets the demands of the DIN EN ISO 9001:2008 standard.



Certificate-no. QS-281 HH

HALFEN FRAMING SYSTEMS

Framing Channels

Framing channels HM, HL, HZM and HZL

Hot-rolled framing channels

The hot-rolling process makes these framing channels ideally suitable for:

- heavy loads
- dynamic loads
- welding

Smooth channels HM

- very high tensile load capacity
- by using nibbed bolts longitudinal loads are possible (applies only to standard steel)

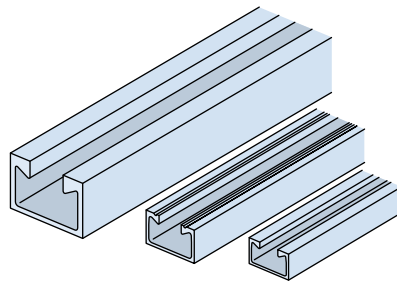

Serrated channels HZM



- serration allows high longitudinal loads
- 5 channel sizes for maximum efficiency

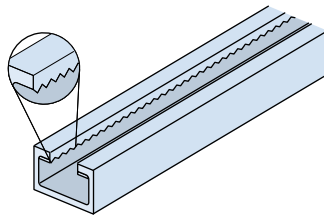

Cold-rolled framing channels

Cold-rolled channels are economic for lower loads. Channels are available with holes or without holes.

Cold-rolled framing channels HL, HM

- economic due to large selection of channels

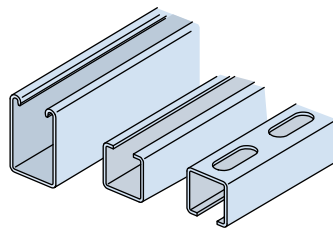

Serrated channels HZL, HZM



- for loads in longitudinal channel direction
- positive-locking connection for high channel loads

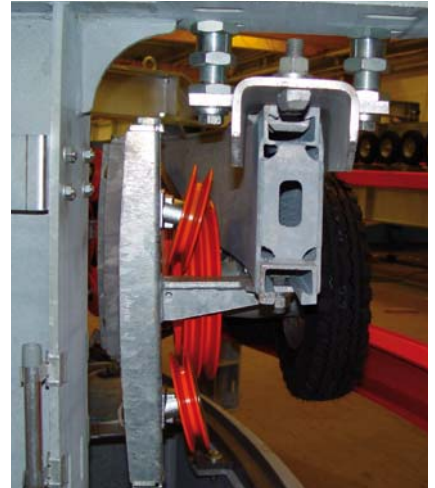
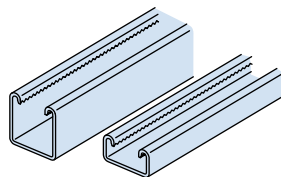

Roller-bearing fixing of a cableway



Welding-jig, locomotive construction

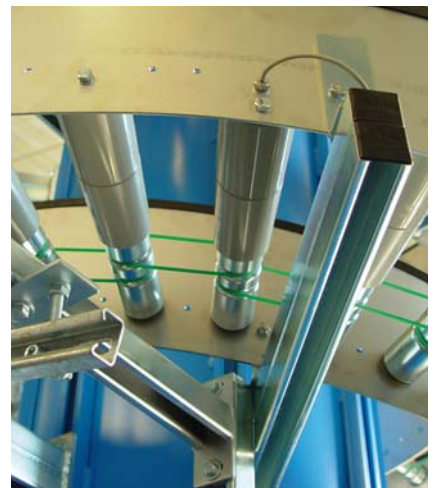

Cantilever fixing on a vertical conveyor system

Framing Channels
Heavy Duty Framing Systems
Medium Duty Framing Systems
Light Duty Framing Systems
Accessories
Statics
Mechanical engineering

HALFEN FRAMING SYSTEMS

HALFEN Bolts

HALFEN Bolts HS, HZS and HSR

Type HS

HALFEN Bolts

- suitable for all channels
- load bearing capacity in two directions
- marked at shank end with one notch

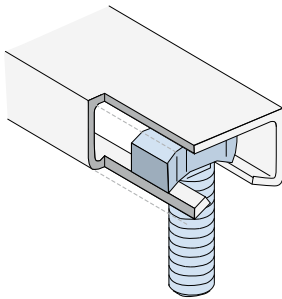

Type HSR

HALFEN Bolts with nibs

- suitable for use in hot-rolled, standard steel channels from the heavy duty system
- nibbed; therefore positive-locking, load bearing in all directions
- the T-bolts prevent turning under vibration
- marked at shank end with two notches

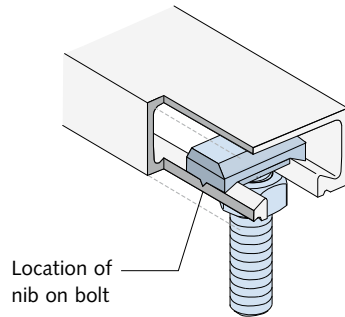

Type HZS



Serrated HALFEN Bolts

- for serrated framing channels HZM and HZL
- serration also provides positive load bearing transmission in longitudinal channel direction; risk of slippage is eliminated
- marked at shank end with two notches

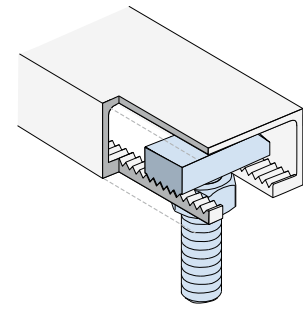

Bolt identification on the bolt head

1
HS All Types
HZS 41/22
HZS 41/41

2
HSR All Types
HZS 38/23
HZS 29/20

Notches on the shank tip:

	Strength class 4.6 galvanized or hot-dip galvanized		Manufacturer (for individual dimensions) Strength class resp. property class
	Strength class 8.8 galvanized or hot-dip galvanized		Property class A4 - 50 stainless steel
			Property class A4 - 70 stainless steel

Marking at the shank end of the HALFEN Bolts: After assembly check the correct orientation of the notches on the shank end of the bolts. The slots must be at right angles to the channel length.

HALFEN FRAMING SYSTEMS

HALFEN Bolts and Locking Plates

Calculating the bolt length l_{req} for HALFEN Bolts (steel construction)

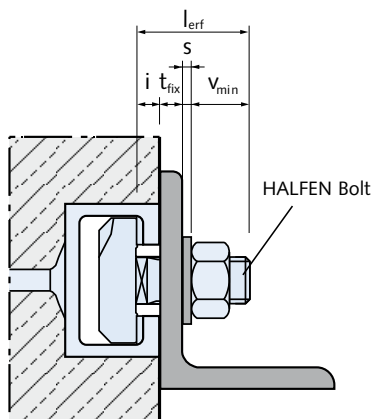

$$l_{req} = t_{fix} + i + s + v_{min}$$

- l_{req} = required bolt length
- t_{fix} = thickness: attached component
- i = channel lip thickness
- s = washer thickness → see page 56

- $v_{min} = m + u$
- m = nut height EN ISO 4032
- u = bolt protrusion approx. 5 mm according to DIN 78 (bolts larger M20 require min. 7 mm)

Dimensions v_{min}	
Bolt diameter	$v_{min} = m + u$ [mm]
M6	11.0
M8	12.5
M10	14.5
M12	17.0
M16	20.5
M20	26.0
M24	29.0
M27	31.5
M30	33.5

Thickness channel lip i

Profile	28/15	29/20	38/17	36/36	38/23	40/22	40/25	41/22	41/27	422	486	49/30	50/30	50/40	52/34	53/34	55/42	64/44	72/48
i [mm]	2.25	5.0	3.0	2.5	5.5	6.0	5.6	7.0	7.0	6.0	6.0	7.39	7.85	7.0	10.5	7.5	12.9	10.0	15.5

Locking plates GWP

Locking plates (channel nuts) allow any metric bolt or threaded rod to be used.

Locking plates with "grip" (see medium duty framing system, page 44). The "serration" grips the channel lips.

Locking plates with spring are used in particular for securing plates or panels (see medium duty framing system, page 44).

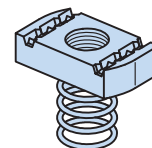
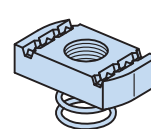
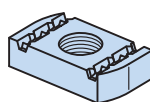
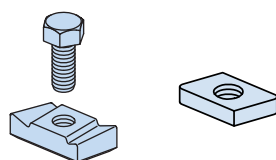

Ordering examples

Order example – framing channels

Type _____ **HM 50/30-FV-6070**
 Material _____
 Length (mm) _____

or use the 12-digit order no. e.g. 0280.200-00003

Order example – HALFEN Bolts

Type _____ **HS 50/30 M20x100 GVs 8.8**
 Thread diam. _____
 Length (mm) _____
 Material _____
 Property class _____

or use the 12-digit order no. e.g. 0350.090-00081
Order numbers for HALFEN Bolts can be found in the HALFEN Pricelist.

Framing Channels

The advantages at a glance

Whether for low or very high loads: you will always find a cost effective solution for your requirements in the HALFEN product range of framing channels and bolts.

Versatile and adaptable

- adjustable assembly
- all connections stay adjustable; they are easily replaced or extended
- almost unlimited in its range of application; e.g. building construction, industrial construction, steel construction, engineering construction, vehicle manufacturing and many other sectors

Secure and reliable

- corrosion protection is not compromised by bolting
- large selection of standard channels with optimal load bearing capacities
- serrated channels for positive-lock connections

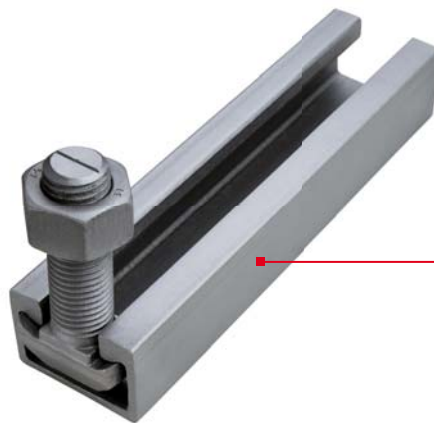

Heavy duty framing system

The heavy duty framing channel is predominantly hot-rolled and particularly suitable for heavy loads.



Medium duty framing system

All medium duty framing channels have the same profile width and are compatible with the innovative HALFEN Powerclick assembly system.







Low duty framing system

The low duty framing channel is the perfect fixing solution for low loads.

HALFEN FRAMING SYSTEMS

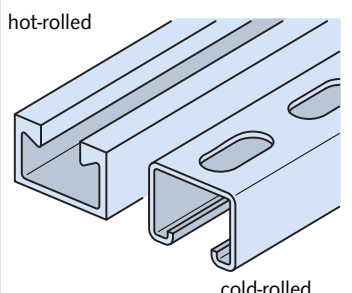
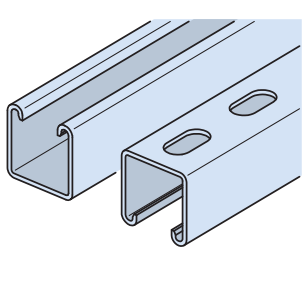
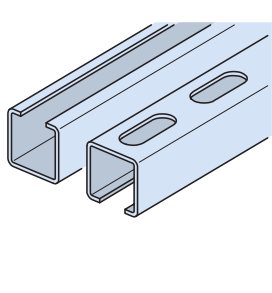
Materials, Types

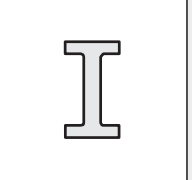
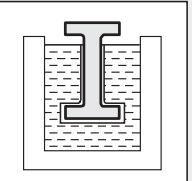
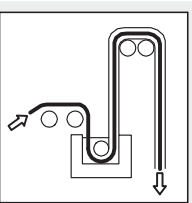
HALFEN Channels

		Heavy duty framing systems	Medium duty framing systems	Light duty framing systems
		 <p>hot-rolled cold-rolled</p> <p>Pages 14 - 34</p>	 <p>Pages 35 - 44</p>	 <p>Pages 45 - 53</p>
<p>Material: Order code </p>				
 <p>Mill-finished</p>	<p>WB</p> <p>Hot-rolled material S235JR, acc. to EN 10025, material no. 1.0038</p> <p>Type HZM: S275JR, material no. 1.0044, acc. to EN 10025</p> <p>Cold-rolled: material S235JR, acc. to EN 10025 mill-finished</p>	<p>Material S235JR, acc. to EN 10025, material no. 1.0038</p>	<p>Material S235JR, acc. to EN 10025, material no. 1.0038</p>	
	 <p>Hot-dip galvanized acc. to EN ISO 1461 suitable for outdoor application</p>	<p>FV</p> <p>Hot-rolled material S235JR, acc. to EN 10025, material no. 1.0038</p> <p>type HZM: S275JR acc. to EN 10025</p> <p>Cold-rolled: material S235JR, acc. to EN 10025 Hot-dip galvanized, acc. to EN ISO 1461, zinc coating min. 50 µm</p>	<p>Material S235JR, acc. to EN 10025, material no. 1.0038</p> <p>Hot-dip galvanized, acc. to EN ISO 1461 zinc coating min. 50 µm</p>	<p>Material S235JR, acc. to EN 10025, material no. 1.0038</p> <p>Hot-dip galvanized, acc. to EN ISO 1461, zinc coating min. 50 µm</p>
 <p>Strip-galvanized acc. to EN 10142 suitable for indoor application</p>	<p>SV</p>	<p>DX51D + Z275NA, material no. 1.0226, acc. to EN 10346</p> <p>Sendzimir galvanized, hot-dip galvanized min. 20 µm</p>	<p>DX51D + Z275NA, material no. 1.0226, acc. to EN 10346</p> <p>Sendzimir galvanized, hot-dip galvanized min. 20 µm</p>	
 <p>Stainless steel acc. to EN 10088 and DIBt-Certificate Z-30.3-6</p>	<p>A2</p>		<p>Material no. 1.4301, acc. to EN 10088</p>	
	<p>A4</p>	<p>Material no. 1.4571 / 1.4404, acc. to EN 10088</p>	<p>Material no. 1.4571 / 1.4404, acc. to EN 10088</p>	
	<p>HCR</p>	<p>HCR = high corrosion resistant stainless steel, material no. 1.4529 or 1.4547, acc. to EN 10088, for channels 49/30</p>	<p>HCR = high corrosion resistant stainless steel, material no. 1.4529 or 1.4547, acc. to EN 10088, for channels 28/15 and 38/17</p>	

HALFEN FRAMING SYSTEMS

Materials, Types

HALFEN Bolts/Accessories

① HALFEN Bolts with s-shape head for safer assembly. The head shape guarantees better hold, preventing the bolt turning in the channel, even coping with manufacturing tolerances in the channel widths. HALFEN supplies both types; subject to change.

Material: Order code

	HALFEN Bolts	Locking plates	Hexagon bolts	Hexagon nuts
	<p>Types HS, HSR, HZS</p> <p>① Standard s-shaped head</p> <p>alternative shape of bolt head</p> <p>incl. nut</p> <p>Pages 54 - 55</p>	<p>Type GWP</p>	<p>Type HSK</p> <p>EN ISO 4017 DIN 933</p> <p>Page 57</p>	<p>Type MU</p> <p>DIN EN ISO 4032 DIN 934</p> <p>Page 56</p>
<p>Hot-dip galvanized acc. to EN ISO 10684, for threaded parts acc. to DIN 267 part 10</p>	<p>FV 4.6 Hot-dip galvanized acc. to EN ISO 10684 property class 4.6 acc. to EN ISO 898-1</p>			<p>Hot-dip galvanized acc. to EN ISO 10684 strength 8</p>
	<p>FV 8.8 Hot-dip galvanized acc. to EN ISO 10684 property class 8.8 acc. to EN ISO 898-1</p>			
<p>Zinc-electroplated acc. to DIN 50961, DIN EN 1403, DIN EN ISO 4042 zinc flake coating</p>	<p>GV 4.6 Zinc-electroplated with special coating Cr(VI)-free, GVs zinc coating min. 12 µm, property class 4.6 acc. to EN ISO 898-1</p>	<p>Zinc-electroplated Cr(VI)-free, zinc cover min. 5 µm</p>		<p>Zinc-electroplated Cr(VI)-free, zinc cover min. 5 µm, property class 8</p>
	<p>GV 8.8 Zinc-electroplated with special coating Cr(VI)-free, GVs zinc coating min. 12 µm, property class 8.8 acc. to EN ISO 898-1</p>		<p>Zinc-electroplated Cr(VI)-free, zinc cover ca. 5 µm, property class 8.8</p>	
	<p>zl Zinc flake coating (only Type HZS 41/41)</p>			
<p>Stainless steel acc. to EN 10088 resp. DIBt-Certificate Z-30.3-6</p>	<p>A2 Property class 50 acc. to EN ISO 3506-1 Property class 70 acc. to EN ISO 3506-1</p>			<p>Stainless steel A2</p>
		<p>Stainless steel A4</p>		
	<p>A4 Property class 50 acc. to EN ISO 3506-1 Property class 70 acc. to EN ISO 3506-1</p>		<p>Stainless steel A4-70</p>	<p>Stainless steel A4-70 or A4-80</p>
	<p>HCR Material HCR-50, material no. 1.4529, acc. to EN ISO 3506-1 on request</p>			
	<p>FA Property class 70 material no. 1.4462</p>			







HALFEN FRAMING SYSTEMS

Product Range Overview: Framing Channels and HALFEN Bolts

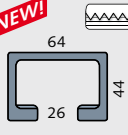
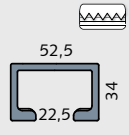
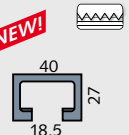
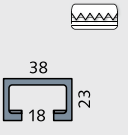
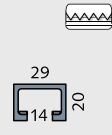
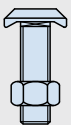
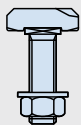

Heavy duty framing system						
Hot-rolled				Cold-rolled		
HM 72/48 ■ ■ ■	HM 55/42 ■	HM 52/34 ■ ■ ■	HM 50/30 ■ ■ ■	HM 49/30 ■ ■ ■ ■	HM 50/40, HL 50/40 ■ ■ ■	HM 486 ■
	NEW!					
HS 72/48, HSR 72/48, GWP 72/48	HS 50/30	HS 50/30, HSR 50/30, GWP 50/30	HS 50/30, GWP 50/30 and GWP 50/40			
Medium duty framing system						
Cold-rolled	Cold-rolled, serrated	Cold-rolled		Cold-rolled, serrated		
HM 41/41, HL 41/41 ■ ■ ■ ■	HZM 41/41, HZL 41/41 ■ ■ ■ ■	HM 41/62, HL 41/62 ■ ■ ■ ■	HM 41/83, HL 41/83 ■ ■ ■ ■	HZL 63/63 ■ ■ ■ ■	HZM 41/22, HZL 41/22 ■ ■ ■ ■	
HZS/HS 41/41, HZS 41/22 GWP 41/41, GWP 41/22						
Light duty framing system						
Cold-rolled						
HM 36/36, HL 36/36 ■ ■ ■ ■	HM 38/17 ■ ■ ■ ■ ■	HM 28/28, HL 28/28 ■ ■ ■ ■ ■	HM 26/26, HL 26/26 ■ ■ ■ ■ ■	HM 28/15, HL 28/15 ■ ■ ■ ■ ■	HM 315 ■ ■ ■ ■ ■	
HS 38/17, GWP 38/17		HS 28/15, GWP 28/15			GWP 28/15	

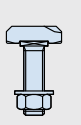
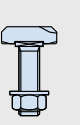
HALFEN FRAMING SYSTEMS

Product Range Overview: Framing Channels and HALFEN Bolts

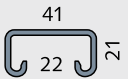
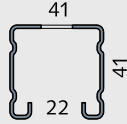
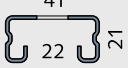
Hot-rolled	Cold-rolled		Hot-rolled, serrated				
HM 40/22	HM 40/25	HM 422	HZM 64/44	HZM 53/34	HZM 41/27	HZM 38/23	HZM 29/20
			NEW! 		NEW! 		
							
HS 40/22, HSR 40/22, GWP 40/22			HZS 64/44	HZS 53/34	HZS 38/23	HZS 38/23, HS 38/17	HZS 29/20, HS 28/15

Cold-rolled		
HM 41/22, HL 41/22	HLL 41/41	HLL 41/22
		

Cold-rolled
HM 20/12, HL 20/12

HS 20/12, GWP 20/12

Material and finishes:

- Hot-dip galvanized FV or mill finish WB
- ▣ Sendzimir galvanized SV
- Stainless steel A4 1.4571/1.4404
- ▣ Stainless steel A2 1.4301/1.4307
- ▣ Stainless steel HCR 1.4547/1.4529

Further information on materials and finishes → see page 10

 HZM/HZL serrated profiles

Steel structures:

A4: Corrosion category III acc. to Z-30.3-6, or acc. to EN 1993-1-4: 2006, table A.1, row 3 (group 1.4571, 1.4404).

A2: Corrosion category II acc. to Z-30.3-6, or acc. to EN 1993-1-4: 2006, table A.1, row 2 (group 1.4301).

HCR: Corrosion category IV acc. to Z-30.3-6, or acc. to EN 1993-1-4: 2006, table A.1, row 4 (group 1.4462, 1.4529, 1.4547).

Framing Channels
Heavy Duty Framing Systems
Medium Duty Framing Systems
Light Duty Framing Systems
Accessories
Statics
Mechanical engineering

HALFEN FRAMING SYSTEMS

Framing Channels – Heavy Duty Framing System

Framing channel HM 72/48

HM 72/48 hot-rolled

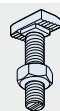
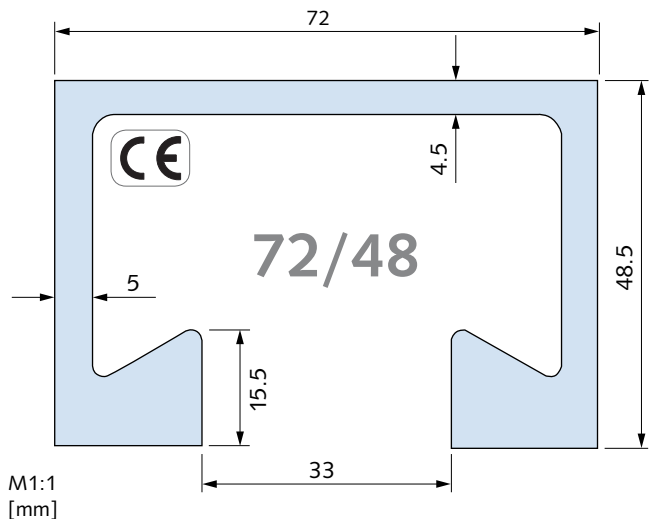

Suitable HALFEN Bolt HS 72/48 and HSR 72/48 → see page 15

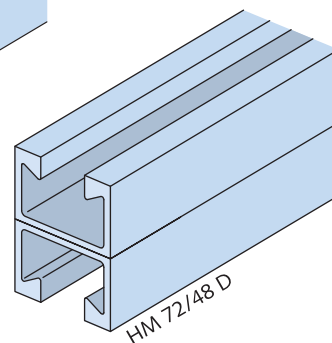
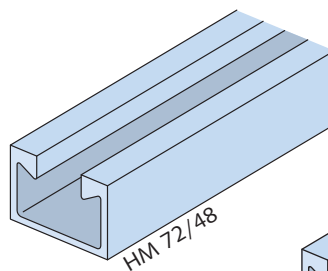

Double channel on request - profile data, see page 60

Dimensions and cross-section properties									Load capacities				
		Length	Weight	Cross section area	Moment of inertia		Elastic section modulus		Max. point-load bearing capacity		Bending load capacity at span L		
Material	Order no.	[mm]	[kg/m]	[cm ²]	I_y [cm ⁴]	I_z [cm ⁴]	W_y [cm ³]	W_z [cm ³]	F_z ① [kN]	e_w [cm]	0.5 m	1.0 m	1.5 m
HM 72/48	0280.								$F_{z,Rd}$		F_{Rd}		
WB	180-00002								65.8	30.0	31.2	15.6	10.4
FV	180-00003	6070	8.85	11.27	34.97	83.35	14.28	23.15	allow. F_z		allow. F		
A4	180-00001								47.0		22.3	11.2	7.4

① F_z = max. load bearing capacity of the channel lips - see also page 66

Accessories

VUS 72/49 Washer
→ see page 56

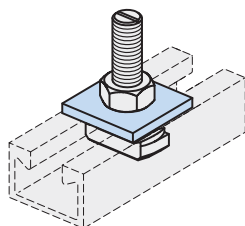

Further design properties

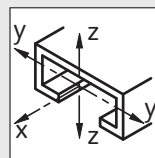

Cross section data
page 60

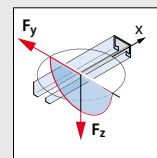

Point-load capacity
pages 66 - 67

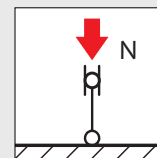

Flexural buckling
page 70

HALFEN FRAMING SYSTEMS

HALFEN Bolts and Accessories – Heavy Duty Framing System

HALFEN Bolts HS 72/48 and HSR 72/48

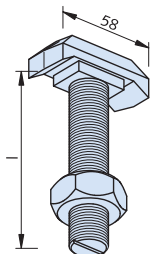

HS 72/48
HALFEN Bolt
incl. nut

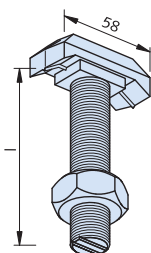

HSR 72/48
HALFEN Bolt with
nib incl. nut, for
hot-rolled channels
in mild steel WB/FV

HS 72/48 available bolts

Length l [mm]	M20	M24	M27	M30	Length l [mm]	M20	M24	M27	M30
50	FV 4.6	FV 4.6 A4-50			150	FV 4.6	FV 4.6 GVs 8.8		FV 4.6
60	FV 8.8								
75	FV 4.6 GVs 8.8	FV 4.6 FV 8.8	FV 4.6	FV 4.6	200	FV 4.6	FV 4.6		FV 4.6
100	FV 4.6 GVs 8.8	FV 4.6 GVs 8.8 A4-50	FV 4.6 FV 8.8	FV 4.6					

HSR 72/48 available bolts

Length l [mm]	M20
75	FV 8.8

Load bearing capacities for HALFEN Bolts ①

Thread Ø	Load capacities for HALFEN Bolts				Recommended load capacity per HALFEN Bolt in channel longitudinal direction				Recommended torque				
	F [kN] ①				F _x [kN]				T _{inst} [Nm]				
72/48	HS			HSR	HS ②			HSR v = 3 ③	HS		HSR		
	4.6	8.8	A4-50	8.8	4.6	8.8	A4-50	8.8	4.6	8.8	A4-50	8.8	
M20	F _{Rd}	35.2	78.4	-	78.4	1.96	6.58	-	10.5	130	360	-	400
	allow. F	25.1	56.0	-	56.0	1.4	4.7	-	7.5				
M24	F _{Rd}	50.7	113.0	44.5	-	2.8	9.52	2.8	-	200	680	200	-
	allow. F	36.2	80.7	31.8	-	2.0	6.8	2.0	-				
M27	F _{Rd}	66.0	146.9	-	-	3.64	12.46	-	-	300	1000	-	-
	allow. F	47.1	104.9	-	-	2.6	8.9	-	-				
M30	F _{Rd}	80.6	-	-	-	4.48	15.26	-	-	400	1400	-	-
	allow. F	57.6	-	-	-	3.2	10.9	-	-				

① Note: do not exceed the max. channel load bearing capacity

② Load capability due to friction

③ Acc. to expert report

Locking plates

Locking plate GWP 72/48

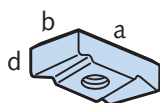

GWP 72/48 available plates

GV thread	A4 thread	a [mm]	b [mm]	d [mm]
M12	M12	62	31	22
M16	M16			
M20	M20			

Load capacities GWP 72/48

Thread	Load capacity [kN]	
M12	F _{Rd}	13.0
	allow. F	9.3
M16	F _{Rd}	24.2
	allow. F	17.3
M20	F _{Rd}	30.8
	allow. F	22.0

HALFEN FRAMING SYSTEMS

Framing Channels – Heavy Duty Framing System

Framing channel HM 55/42

HM 55/42 hot-rolled

NEW!

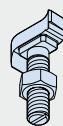
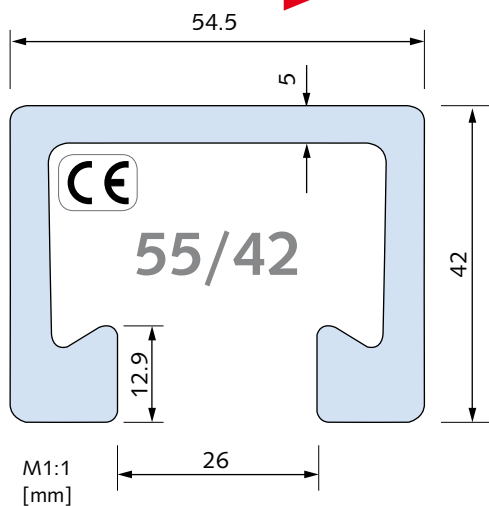

Suitable HALFEN Bolt HS 50/30, see page 21

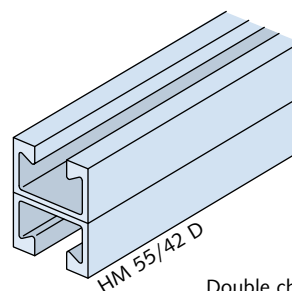
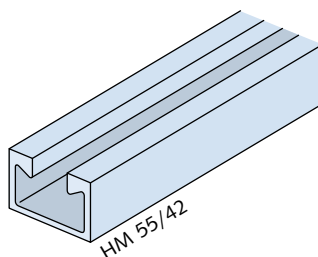

Double channel on request - profile data, see page 60

Dimensions and cross-section properties

Load capacities

Material	Order no.	Length [mm]	Weight G [kg/m]	Cross section area A [cm ²]	Moment of inertia		Elastic section modulus		Max. point-load bearing capacity		Bending load capacity at span L		
					I_y [cm ⁴]	I_z [cm ⁴]	W_y [cm ³]	W_z [cm ³]	F_z ① [kN]	e_w [cm]	F [kN]		
HM 55/42	0280.										0.5 m	1.0 m	1.5 m
WB	290-00001	6070	6.76	8.6	18.75	36.29	8.49	13.32	$F_{z,Rd}$	25.0	F_{Rd}		
									54.0		23.5	11.7	7.8
FV	290-00002								allow. F_z		allow. F		
									38.6		16.8	8.4	5.6

① F_z = max. load bearing capacity of the channel lips - see also page 66

Accessories

VUS 72/49 Washer

→ see page 56

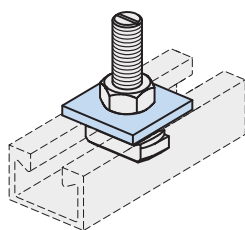

Further design properties

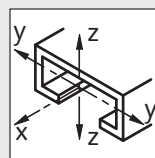

Cross section data
page 60

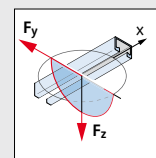

Point-load capacity
pages 66 - 67

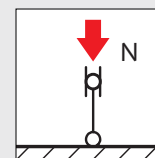

Flexural buckling
page 70

HALFEN FRAMING SYSTEMS

Framing Channels – Heavy Duty Framing System

Framing channel HM 52/34

HM 52/34 hot-rolled

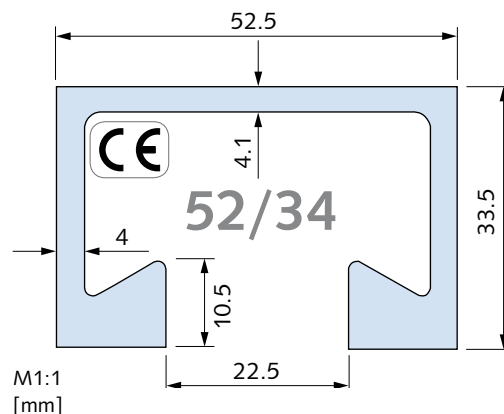

Suitable HALFEN Bolts and locking plates
 HS 50/30, HSR 50/30, GWP 50/40 and
 GWP 50/30 → see pages 21 - 22

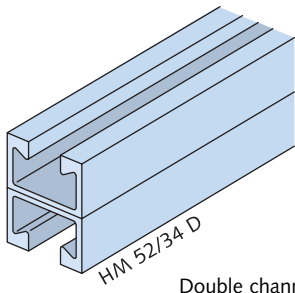
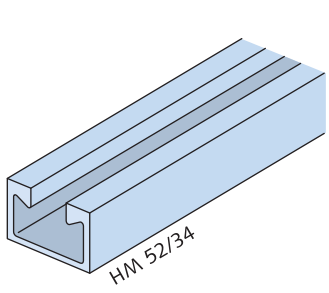

Double channel on request
 - profile data, see page 60

Dimensions and cross-section properties

		Length [mm]	Weight G [kg/m]	Cross section area A [cm ²]	Moment of inertia		Elastic section modulus		Load capacities				
Material	Order no.				I_y [cm ⁴]	I_z [cm ⁴]	W_y [cm ³]	W_z [cm ³]	Max. Point-load bearing capacity		Bending load capacity at span L		
HM 52/34	0280.	[mm]							F_z ① [kN]	e_w [cm]	0.5 m	1.0 m	1.5 m
WB	190-00002	6070	4.98	6.35	9.33	23.74	5.36	9.04	$F_{z,Rd}$	20.0	F_{Rd}		
FV	190-00003								36.3		12.3	6.7	3.9
A4	190-00001								allow. F_z		allow. F		
									25.9		8.8	4.4	2.8

① F_z = max. load bearing capacity of the channel lips - see also page 66

Accessories

VUS 52/34 Washer
 → see page 56

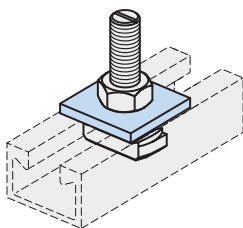

PA - 22 Channel cover
 → see page 58

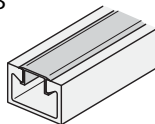

HPE 52/34 Channel end cap
 → see page 58

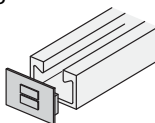

Further design properties

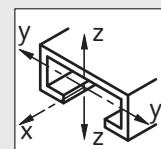

Cross section data
 page 60

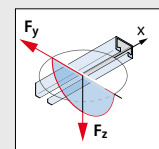

Point-load capacity
 pages 66 - 67

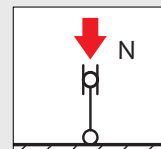

Flexural buckling
 page 70

HALFEN FRAMING SYSTEMS

Framing Channels - Heavy Duty Framing System

Framing channel HM 50/30 and HM 49/30

HM 50/30 hot-rolled

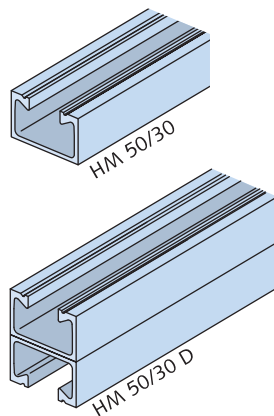
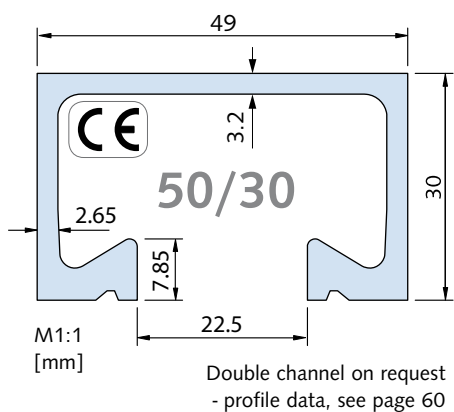

HM 49/30 cold-rolled

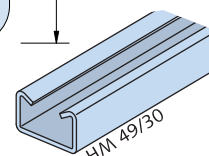
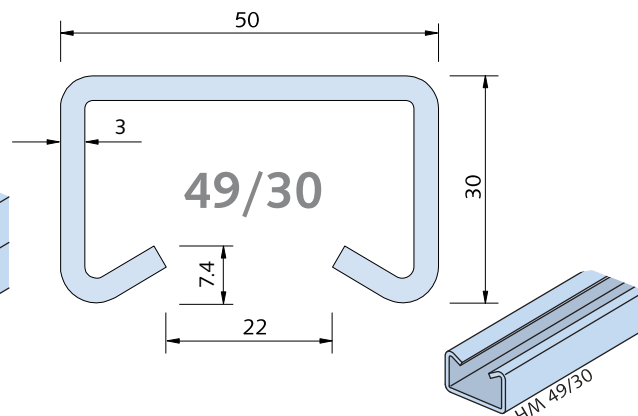

Dimensions and cross-section properties									Load capacities				
Material	Order no.	Length [mm]	Weight G [kg/m]	Cross section area A [cm ²]	Moment of inertia		Elastic section modulus		Max. point-load bearing capacity		Bending load capacity at span L		
					I_y [cm ⁴]	I_z [cm ⁴]	W_y [cm ³]	W_z [cm ³]	F_z [kN]	e_w [cm]	F [kN]		
											0.5 m	1.0 m	1.5 m
HM 50/30	0280.								$F_{z,Rd}$		F_{Rd}		
WB	200-00002								20.2		7.5	3.7	2.2
FV	200-00003	6070	3.26	4.15	5.19	13.99	3.24	5.67	allow. F_z	20	allow. F		
A4	200-00001								14.4		5.3	2.7	1.6
HM 49/30	0280.								$F_{z,Rd}$		F_{Rd}		
WB	220-00001								6.9		6.1	3.0	1.7
FV	220-00002	6070	2.88	3.67	4.16	13.23	2.35	5.29	allow. F_z	46	allow. F		
A2	220-00003										4.3	2.2	1.2
A4	220-00004								4.9				

① F_z = max. load bearing capacity of the channel lips; ② Stainless steel A2 on request. Note: HCR for HM 49/30 on request

Accessories

VUS 52/34 Washer
→ see page 56

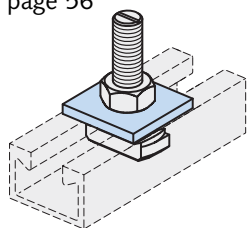

PA - 41 Channel cover
→ see page 58

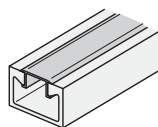

SIC 50/30 Locking washer
→ see page 56

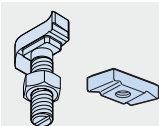
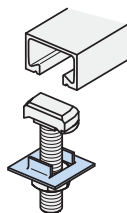

Suitable HALFEN Bolts and locking plates
HS 50/30, HSR 50/30 and
GWP 50/30 → see pages 21 - 22

Further design properties

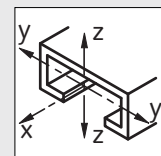

Cross section data
pages 60, 62

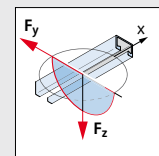

Point-load capacity
pages 66 - 67

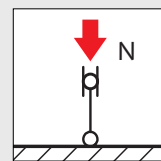

Flexural buckling
pages 70 - 71

HALFEN FRAMING SYSTEMS

Framing Channels - Heavy Duty Framing System

Framing channel HM and HL 50/40

HM 50/40 and HL 50/40 cold-rolled

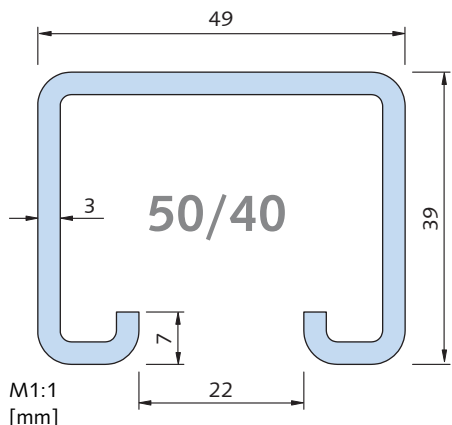

Suitable HALFEN Bolts and locking plates
HS 50/30, GWP 50/40
→ see pages 21 - 22

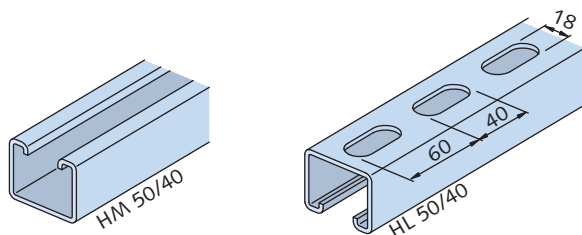

Dimensions and cross-section properties									Load capacities				
Material	Order no.	Length	Weight	Cross section area	Moment of inertia		Elastic section modulus		Max. point-load bearing capacity		Bending load capacity at span L		
			G	A	I_y	I_z	W_y	W_z	F_z	e_w	F [kN]		
		[mm]	[kg/m]	[cm ²]	[cm ⁴]	[cm ⁴]	[cm ³]	[cm ³]	[kN]	[cm]	0.5 m	1.0 m	1.5 m
HM 50/40	0280.	6000	3.35	4.26	8.64	15.49	3.96	6.32	$F_{z,Rd}$	63.0	F_{Rd}		
WB	090-00002								7.6		9.5	4.7	3.2
FV	090-00003								allow. F_z		allow. F		
A4	090-00001								5.4		6.8	3.4	2.3
HL 50/40	0281.	6000	3.15	3.73	7.14	15.36	3.65	6	$F_{z,Rd}$	53.0	F_{Rd}		
WB	100-00001								7.6		8.0	4.1	2.7
FV	100-00002								allow. F_z		allow. F		
A4	100-00003								5.4		5.7	2.9	1.9

① F_z = max. load bearing capacity of the channel lips

Accessories

HPE 50/40 Channel end cap
→ see page 58

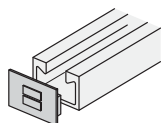

PA - 41 Channel cover
→ see page 58

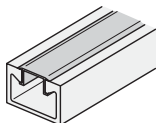

Further design properties

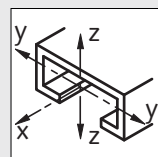

Cross section data
pages 62, 64

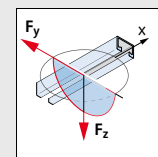

Point-load capacities
page 68

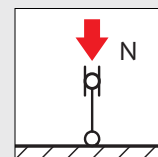

Flexural buckling
page 71

HALFEN FRAMING SYSTEMS

Framing Channels - Heavy Duty Framing System

Framing channel HM 486

HM 486 cold-rolled

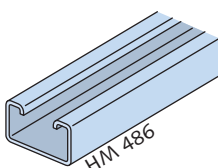
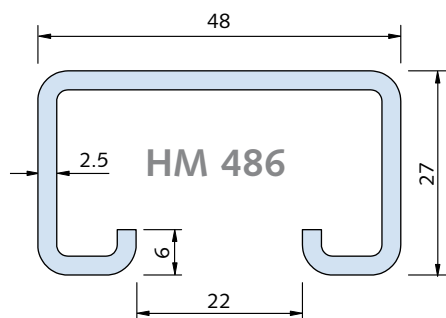

Suitable HALFEN Bolts and locking plates
HS 50/30 and GWP 50/40
→ see pages 21 - 22

M1:1
[mm]

Dimensions and cross-section properties									Load capacities				
Material	Order no.	Length	Weight	Cross section area	Moment of inertia		Elastic section modulus		Max. point-load bearing capacity		Bending load capacity at span L		
			G	A	I_y	I_z	W_y	W_z	F_z	$\leq e_w$			
HM 486	0280.	[mm]	[kg/m]	[cm ²]	[cm ⁴]	[cm ⁴]	[cm ³]	[cm ³]	F_z ①		0.5 m	1.0 m	1.5 m
WB	100-00001	6000	2.31	2.95	2.97	9.62	1.92	4.01	$F_{Rd,z}$	47.0	F_{Rd}		
	4.7								4.6		2.3	1.2	
FV	100-00002								allow. F_z		allow. F		
									3.5		3.3	1.7	0.9

① F_z = load bearing capacity of the channel lips

Accessories

PA - 41 Channel cover
→ see page 58

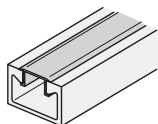

Further design properties

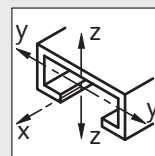

Cross section data
page 62

HALFEN FRAMING SYSTEMS

HALFEN Bolts and Accessories – Heavy Duty Framing System

HALFEN Bolts HS 50/30 and HSR 50/30

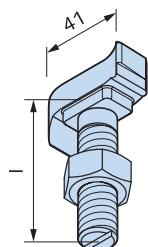

HS 50/30
HALFEN Bolt
incl. nut

Li = left-hand thread
T = partial thread

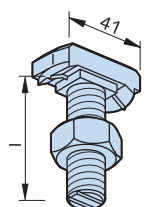

HSR 50/30
HALFEN Bolt with nib,
incl. nut, for hot-rolled
profiles in mild steel
WB/FV

HS 50/30 available bolts											
Length l [mm]	Thread					Length l [mm]	Thread				
	M10	M12	M16	M20	M24 ①		M10	M12	M16	M20	M24 ①
30	GVs 4.6	GVs 4.6	GVs 4.6	-	-	75	-	-	-	GVs 4.6	FV 4.6
	FV 4.6	A4-70	A4-50	-	-		-	-	-	A4-50	FA-70
35	-	-	-	GVs 4.6	-	-	-	-	-	-	-
40	GVs 4.6	GVs 4.6	GVs 4.6	-	-	80	-	GVs 4.6	GVs 4.6	GVs 8.8	-
	-	FV 4.6	GVs 8.8	-	-		-	GVs 8.8	GVs 8.8	-	-
-	-	A4-70	FV 4.6	-	-	-	-	A4-50	A4-70	-	-
-	-	-	A4-50	-	-	-	-	-	-	-	-
45	-	GVs 8.8	-	GVs 4.6	-	80 Li	-	-	A4-50	-	-
-	-	-	-	GVs 8.8	-	-	-	GVs 4.6	GVs 4.6	GVs 4.6	-
-	-	-	-	A4-50	-	-	-	A4-50	GVs 8.8	GVs 8.8	-
50	GVs 4.6	GVs 4.6	GVs 4.6	-	-	100	-	-	-	FV 4.6	FV 4.6
-	-	A4-70	FV 4.6	-	-	-	-	-	-	A4-50	A4-50
-	-	-	A4-50	-	-	-	-	-	-	FA-70	-
55	-	-	-	GVs 4.6	-	100 T	-	-	A4-50	-	-
-	-	-	-	FV 4.6	-	125	-	GVs 4.6	GVs 4.6	GVs 4.6	-
-	-	-	-	A4-50	-	-	-	-	-	A4-50	-
60	-	GVs 4.6	GVs 4.6	GVs 8.8	-	150	-	GVs 4.6	GVs 4.6	GVs 4.6	-
	-	GVs 8.8	GVs 8.8	FV 8.8	-		-	-	FV 4.6	GVs 8.8	-
-	-	-	A4-50	-	-	200	-	GVs 4.6	GVs 4.6	GVs 4.6	-
65	-	-	-	GVs 4.6	-	300	-	-	GVs 4.6	GVs 4.6	-

① For HM 55/42 only
High corrosion resistant stainless steel HCR for HS 50/30 on request

HSR 50/30 available bolts									
Length l [mm]	Thread				Length l [mm]	Thread			
	M10	M12	M16	M20		M10	M12	M16	M20
40	-	-	-	FV 8.8	-	-	-	-	-
45	-	-	-	-	75	-	-	-	GVs 8.8
60	-	-	-	GVs 8.8	GVs 8.8	-	-	-	-

Load bearing capacities for HALFEN Bolts ①

Thread Ø	Load capacities for HALFEN Bolts							Recommended load capacity per HALFEN Bolt in channel longitudinal direction					Recommended torque						
		F [kN]						F _x [kN]					T _{inst} [Nm]						
		HS	HSR	HS ②			HSR ③	HS		HSR	HS			HSR					
50/30			4.6	8.8	A4-50	A4-70	FA-70	8.8	4.6	8.8	A4-50; A4-70	FA-70	8.8	4.6	8.8	A4-50	A4-70	FA-70	8.8
M10	F _{Rd}	8.3	18.6	-	-	-	-	0.42	1.54	-	-	-	-	15	40	-	-	-	-
	allow. F	5.9	13.3	-	-	-	-	0.3	1.1	-	-	-	-	-	-	-	-	-	-
M12	F _{Rd}	12.1	27.0	10.6	22.7	-	-	0.7	2.24	0.7	-	-	-	25	70	25	-	-	-
	allow. F	8.6	19.3	7.6	16.2	-	-	0.5	1.6	0.5	-	-	-	-	-	-	-	-	-
M16	F _{Rd}	22.6	50.2	19.8	42.2	-	50.2	1.26	4.2	1.26	-	7.0	-	65	180	60	130	-	200
	allow. F	16.1	35.9	14.1	30.2	-	35.9	0.9	3.0	0.9	-	5.0	-	-	-	-	-	-	-
M20	F _{Rd}	35.2	78.4	30.9	-	66.0	78.4	1.96	6.58	1.96	1.96	10.5	-	130	360	120	-	250	400
	allow. F	25.1	56.0	22.1	-	47.1	56.0	1.4	4.7	1.4	1.4	7.5	-	-	-	-	-	-	-
M24	F _{Rd}	50.7	-	-	-	-	-	2.8	9.5	-	-	-	-	230	-	-	-	-	-
	allow. F	36.2	-	-	-	-	-	2.0	6.8	-	-	-	-	-	-	-	-	-	-

① Note: do not exceed the max. channel load bearing capacity
② Load capability due to friction
③ acc. to expert report, v = 3

HALFEN FRAMING SYSTEMS

HALFEN Bolts and Accessories – Heavy Duty Framing System

Locking plates GWP 50/30

Locking plate
GWP 50/30

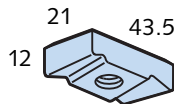

GWP 50/30 available bolts

FV	GV	A4
-	M8	M8
M10	M10	M10
M12	M12	M12
M16	M16	M16

Load capacities for locking plates 50/30

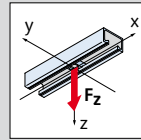

50/30

Thread	Load capacity [kN]	
	F_{Rd}	allow. F
M8	5.6	4.0
M10	9.0	6.4
M12	13.0	9.3
M16	13.0	9.3

Locking plates GWP 50/40

Locking plate
GWP 50/40

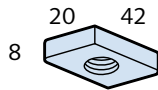

GWP 50/40 available bolts

GV	A4
M6	M6
M8	M8
M10	M10
M12	M12
M16	M16

Load capacities for locking plates 50/40

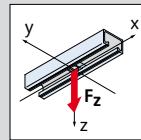

50/40

Thread	Load capacity [kN]	
	F_{Rd}	allow. F
M6	3.1	2.2
M8	5.6	4.0
M10	9.0	6.4
M12	9.0	6.4
M16	9.0	6.4

HALFEN FRAMING SYSTEMS

Framing Channels – Heavy Duty Framing System

Framing channel HM 40/22, HM 40/25

HM 40/22 hot-rolled

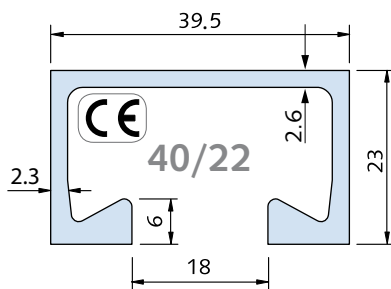

M1:1
[mm]

Double channel on request - profile data, see page 60

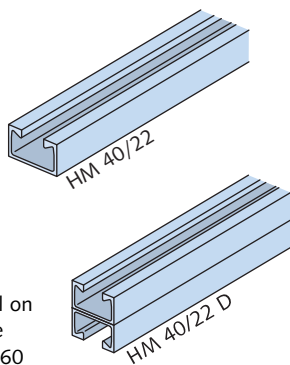

HM 40/25 cold-rolled

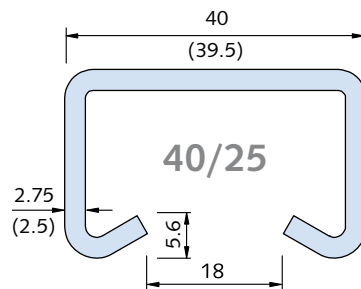

Values in brackets for stainless steel A2 and A4

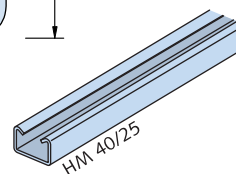

Dimensions and cross-section properties								Load capacities					
Material	Order no.	Length [mm]	Weight G [kg/m]	Cross section area A [cm ²]	Moment of inertia [cm ⁴]		Elastic section modulus [cm ³]		Max. point-load bearing capacity		Bending load capacity at span L		
					I_y	I_z	W_y	W_z	F_z ①	e_w			
											0.5 m	1.0 m	1.5 m
HM 40/22	0280.												
WB	210-00002								$F_{z,Rd}$		F_{Rd}		
FV	210-00003	6070	2.12	2.70	1.98	5.77	1.59	2.92	11.4		3.7	1.9	0.8
A4	210-00001								allow. F_z	15.0	allow. F		
									8.2		2.6	1.3	0.6
HM 40/25	0280.												
WB	230-00001								$F_{z,Rd}$		F_{Rd}		
FV	230-00002	6070	2.09	2.66	2.05	6.09	1.39	3.05	5.3		3.6	1.8	0.9
A2	230-00003								allow. F_z	33.0	allow. F		
A4	230-00004								3.8		2.6	1.3	0.6

① F_z = max. load bearing capacity for the channel lips - see also page 66

Accessories

VUS 40/25

Washer
→ see page 56

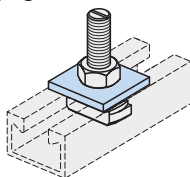

SIC 40/22

Locking washer
→ see page 56

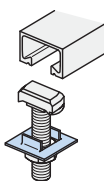

SDM - 36/6

Rubber vibration absorber
→ see catalogue MT-FFC

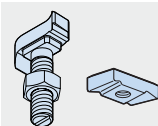
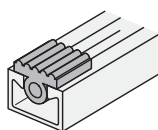

Suitable HALFEN Bolts and locking plates
HS 40/22, HSR 40/22 and
GWP 40/22 → see page 25

Further design properties

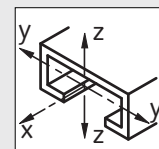

Cross section data
pages 60, 62

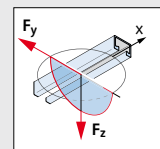

Point-load capacities
pages 66 - 67

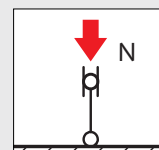

Flexural buckling
pages 70 - 71

HALFEN FRAMING SYSTEMS

Framing Channels - Heavy Duty Framing System

Framing channel HM 422

HM 422 (C40) cold-rolled

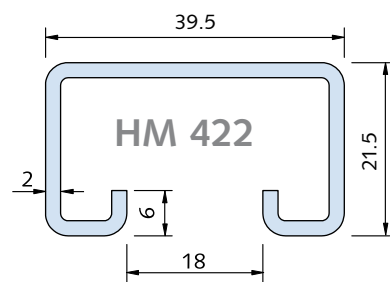

M1:1
[mm]

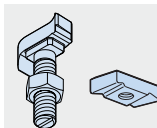
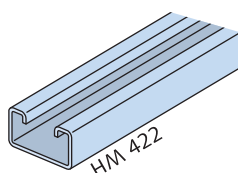

Suitable HALFEN Bolts and locking plates
HS 40/22 and GWP 40/22
→ see page 25

Dimensions and cross-section properties								Load capacities					
Material	Order no.	Length [mm]	Weight G [kg/m]	Cross section area A [cm ²]	Moment of inertia		elastic section modulus		Max. point-load bearing capacity		Bending load capacity at span L		
					I_y [cm ⁴]	I_z [cm ⁴]	W_y [cm ³]	W_z [cm ³]	F_z ① [kN]	e_w [cm]	F [kN]		
HM 422	0280.												
WB	110-00001	6000	1.55	1.98	1.27	4.29	1.04	2.17	$F_{z,Rd}$	36.0	F_{Rd}		
FV	110-00002								3.5		2.5	2.5	1.8
									allow. F_z		allow. F		

① F_z = max. load bearing capacity of the channel lips

Accessories

VUS 40/25

Washer
→ see page 56

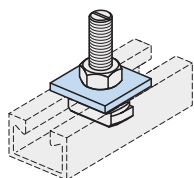

SIC 40/22

Locking washer
→ see page 56

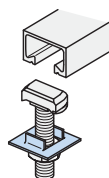

SDM - 36/6

Rubber vibration absorber
→ see catalogue MT-FFC

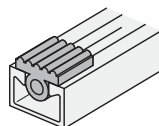

Further design properties

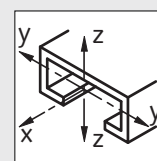

Cross section data
page 62

HALFEN FRAMING SYSTEMS

HALFEN Bolts and Accessories – Heavy Duty Framing System

HALFEN Bolts HS 40/22 and HSR 40/22

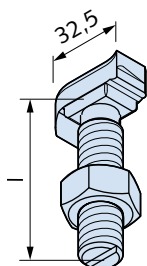

HS 40/22
HALFEN Bolt
incl. nut

Li = left-hand thread

HSR 40/22

HALFEN Bolt with nib,
incl. nut, for hot-rolled
profiles in mild steel
WB/FV

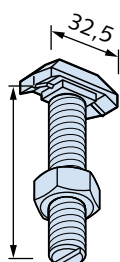

HS 40/20 available bolts

Length l [mm]	HS 40/20 available bolts			Length l [mm]	HS 40/20 available bolts		
	M10	M12	M16		M10	M12	M16
20	GVs 4.6	GVs 4.6		60	GVs 4.6	GVs 4.6	GVs 4.6
30	GVs 4.6 A4-70	GVs 4.6 GVs 8.8 FV 4.6 A4-50	GVs 4.6 A4-50			GVs 4.6	GVs 4.6 GVs 8.8 A4-50
	40	GVs 4.6 A4-70	GVs 4.6 GVs 8.8 A4-50 A4-70	GVs 4.6 A4-50 A4-70	80 Li	-	A4-50
45			GVs 8.8		100	GVs 4.6	GVs 4.6 GVs 8.8 A4-50
	50	GVs 4.6 A4-70	GVs 4.6 FV 4.6 A4-50	GVs 4.6 FV 4.6 A4-50 A4-70	125	-	GVs 4.6
				150	-	GVs 4.6 A4-50	GVs 4.6 A4-50
				200	-	GVs 4.6	GVs 4.6
				250	-	-	GVs 4.6
				300	-	-	GVs 4.6

HSR 40/22 available bolts

Length l [mm]	M10	M12	M16
40	-	-	GVs 8.8
60	-	-	GVs 8.8

Load bearing capacities for HALFEN Bolts ①

Thread Ø	Load capacities for HALFEN Bolts					Recommended load capacity per HALFEN Bolt in channel longitudinal direction ②					Recommended torque				
	F [kN]					F _x [kN]					T _{inst} [Nm]				
40/22	HS				HSR	HS				HSR ③	HS				HSR
	4.6	8.8	A4-50	A4-70	8.8	4.6	8.8	A4-50	A4-70	8.8	4.6	8.8	A4-50	A4-70	8.8
M10	F _{Rd}	8.3	-	-	15.6	-	-	-	0.42	-	15	-	-	30	-
	allow. F	5.9	-	-	11.2	-	0.3	-	0.3	-	-	-	-	-	-
M12	F _{Rd}	12.1	27.0	10.6	-	-	-	0.7	-	-	25	70	25	-	70
	allow. F	8.6	19.3	7.6	-	-	0.5	0.5	-	-	-	-	-	-	-
M16	F _{Rd}	22.6	50.2	19.8	42.2	50.2	-	1.26	1.26	7.0	65	180	60	130	200
	allow. F	16.1	35.9	14.1	30.2	39.9	0.9	3.0	0.9	0.9	5.0	-	-	-	-

① Note: do not exceed the channel load bearing capacity

② Load capability due to friction

③ acc. to expert report, $\nu = 3$

Locking plates GWP 40/22

Locking plate
GWP 40/22

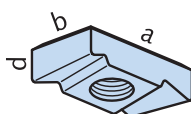

GWP 40/22 available plates

GV	A4	a [mm]	b [mm]	d [mm]
M5	-	35	17	10
M6	-			
M8	M8			
M10	M10			
M12	M12			

Load capacities for GWP 40/22

Thread	Load capacity [kN]	
	F _{Rd}	allow. F
M5	F _{Rd}	3.1
	allow. F	2.2
M6	F _{Rd}	3.1
	allow. F	2.2
M8	F _{Rd}	5.6
	allow. F	4.0
M10	F _{Rd}	9.0
	allow. F	6.4
M12	F _{Rd}	13.0
	allow. F	9.3

HALFEN FRAMING SYSTEMS

Framing Channels - Heavy Duty Framing System

Framing channel HZM 64/44

HZM 64/44 hot-rolled, serrated

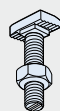

Suitable HALFEN Bolts
HZS 64/44 → see page 27

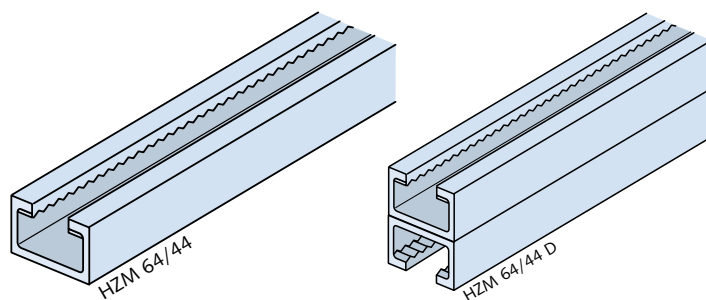
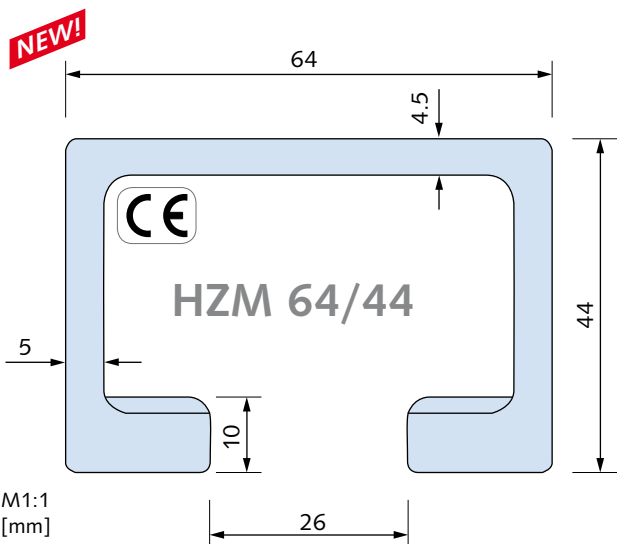

Double channel on request
- profile data, see page 60

Dimensions and cross-section properties									Load capacities				
Material	Order no.	Length [mm]	Weight G [kg/m]	Cross section area A [cm ²]	Moment of inertia		Elastic section modulus		Max. point-load bearing capacity		Bending load capacity at span L		
					I_y [cm ⁴]	I_z [cm ⁴]	W_y [cm ³]	W_z [cm ³]	F_z ① [kN]	$\leq e_w$ [cm]	F [kN]		
HZM 64/44	0284.										0.5 m	1.0 m	1.5 m
WB	080-00002	6070	7.15	9.1	23.83	53.94	10.36	16.85	$F_{z,Rd}$	25.0	F_{Rd}		
FV	080-00003								53.3		34.8	17.4	10.0
A4	080-00001								allow. F_z		allow. F		
											24.8	12.4	7.1

① F_z = max. load bearing capacity of the channel lips - see also page 66

Accessories

VUS 72/48

Washer

→ see page 56

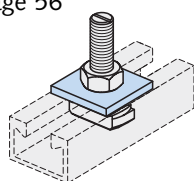

Further design properties

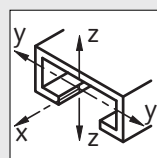

Cross section data
page 60

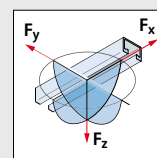

Point-load capacities
pages 66 - 67

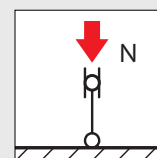

Flexural buckling
page 70

HALFEN FRAMING SYSTEMS

HALFEN Bolts – Heavy Duty Framing System

HALFEN Bolts HZS 64/44

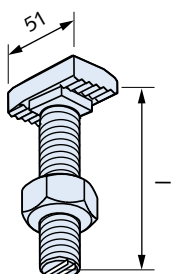

HZS 64/44
HALFEN Bolt,
serrated
incl. nut

HZS 64/44 available bolts		
Length l [mm]	M20	M24
80	GVs 8.8 A4-70	GVs 8.8 A4-70
125	GVs 8.8 A4-70	-
150	-	GVs 8.8 A4-70

Load bearing capacities for HALFEN Bolts ①

Thread Ø	Load capacities for HALFEN Bolts		Max. load capacity per HALFEN Bolt in channel longitudinal direction		Recommended torque		
	F [kN] ①		F _x [kN] ①		T _{inst} [Nm]		
64/44	HZS		HZS		HZS		
		8.8	A4-70	8.8	A4-70	8.8	A4-70
M20	F _{Rd}	79.0	51.5	37.8	37.8	350	350
	allow. F	56.4	36.8	27.0	27.0		
M24	F _{Rd}	113.7	54.3	37.8	37.8	450	450
	allow. F	81.2	38.8	27.0	27.0		

① Note: do not exceed the max. channel load bearing capacity

In case of simultaneously loading in all directions (longitudinal -x, transverse -y, central tension -z) the resultant load must not exceed the load bearing capacity given in the table.

$$\sqrt{F_x^2 + F_y^2 + F_z^2} \leq \text{allow. F}$$

resp.

$$\sqrt{F_{x,Ed}^2 + F_{y,Ed}^2 + F_{z,Ed}^2} \leq F_{Rd}$$

F_x, F_y, F_z = existing loads

allow. F = allowable load bearing capacity of the bolt

resp.

F_{x,Ed}, F_{y,Ed}, F_{z,Ed} = design values of action

F_{Rd} = design value of resistance

HALFEN FRAMING SYSTEMS

Framing Channels - Heavy Duty Framing System

Framing channel HZM 53/34

HZM 53/34 hot-rolled, serrated

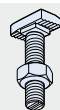
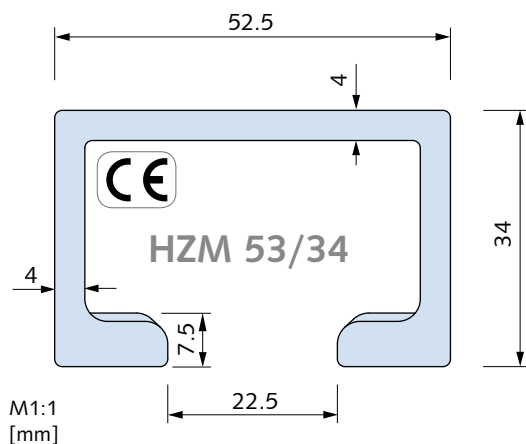

Suitable HALFEN Bolts HZS 53/34
→ see page 29

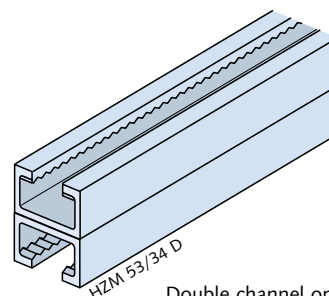
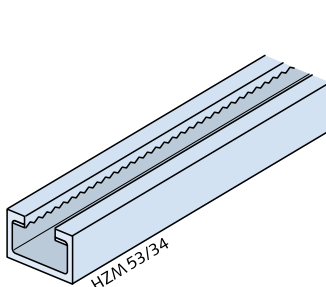

Double channel on request
- profile data, see page 60

Dimensions and cross-section properties									Load capacities				
Material	Order no.	Length [mm]	Weight G [kg/m]	Cross section area A [cm ²]	Moment of inertia		Elastic section modulus		Max. point-load bearing capacity	Bending load capacity at span L			
					I_y	I_z	W_y	W_z	F_z ①	e_w			
											0.5 m	1.0 m	1.5 m
HZM 53/34	0284.								$F_{z,Rd}$	20.0	F_{Rd}		
WB	070-00002	6070	4.63	5.88	9.19	23.18	4.95	8.83	43.3		17.3 8.6 3.8		
FV	070-00003								allow. F_z		allow. F		
A4	070-00001								30.9	12.4 6.2 2.7			

① F_z = max. load bearing capacity of the channel lips - see also page 66

Accessories

VUS 52/34

Washer

→ see page 56

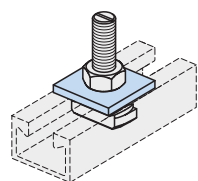

PA - 22

Channel cover

→ see page 58

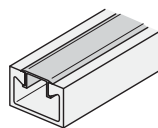

Further design properties

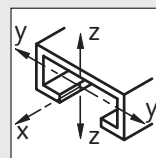

Cross section data
page 60

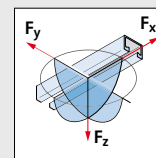

Point-load capacities
pages 66 - 67

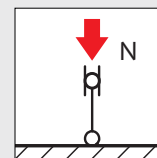

Flexural buckling
page 70

HALFEN FRAMING SYSTEMS

HALFEN Bolts – Heavy Duty Framing System

HALFEN Bolts HZS 53/34

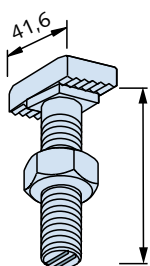

HZS 53/34
HALFEN Bolt,
serrated
incl. nut

HZS 53/34 available bolts

Length l [mm]	M16	M20
60	GVs 8.8 A4-70	-
65	-	GVs 8.8 A4-70
100	GVs 8.8 A4-70	GVs 8.8 A4-70

Load bearing capacities for HALFEN Bolts ①

Thread Ø	Load capacities for HALFEN Bolts		Max. load capacity per bolt in channel longitudinal direction		Recommended torque		
	 F [kN] ①		 F _x [kN] ①		 T _{inst} [Nm]		
53/34	HZS		HZS		HZS		
		8.8	A4-70	8.8	A4-70	8.8	A4-70
M16	<i>F_{Rd}</i>	50.5	33.0	30.8	26.6	200	200
	allow. F	36.1	23.6	22.0	19.0		
M20	<i>F_{Rd}</i>	79.0	51.5	30.8	26.6	350	350
	allow. F	56.4	36.8	22.0	19.0		

① Note: do not exceed the max. channel load bearing capacity

In case of simultaneously loading in all directions (longitudinal -x, transverse -y, central tension -z) the resultant load must not exceed the load bearing capacity given in the table.



$$\sqrt{F_x^2 + F_y^2 + F_z^2} \leq \text{allow. F}$$

resp.

$$\sqrt{F_{x,Ed}^2 + F_{y,Ed}^2 + F_{z,Ed}^2} \leq F_{Rd}$$

F_x, F_y, F_z = existing loads

allow. F = allowable load bearing capacity of the bolt

resp.

F_{x,Ed}, F_{y,Ed}, F_{z,Ed} = design values of action

F_{Rd} = design value of resistance

HALFEN FRAMING SYSTEMS

Framing Channels - Heavy Duty Framing System

Framing channel HZM 41/27

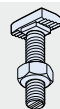
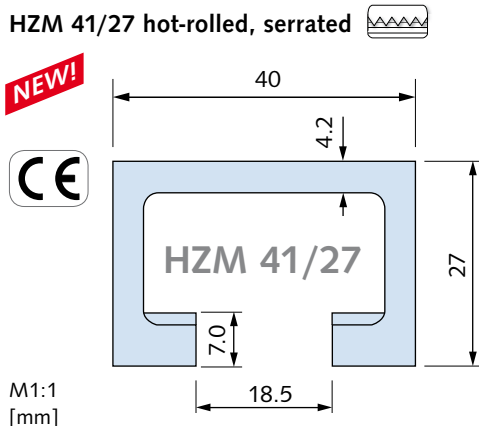

Suitable HALFEN Bolts HZS 38/23
→ see page 32

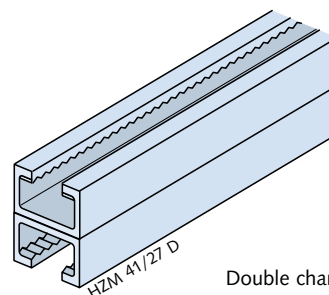
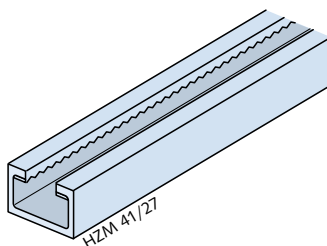

Double channel on request
- profile data, see page 60

Dimensions and cross-section properties									Load capacities				
Material	Order no.	Length [mm]	Weight G [kg/m]	Cross section area A [cm ²]	Moment of inertia I_y [cm ⁴] I_z [cm ⁴]		Elastic section modulus W_y [cm ³] W_z [cm ³]		Max. point-load bearing capacity		Bending load capacity at span L		
										F_z ≤ e_w			
HZM 41/27	0284.	[mm]	[kg/m]	[cm ²]	I_y [cm ⁴]	I_z [cm ⁴]	W_y [cm ³]	W_z [cm ³]	F_z ① [kN]		0.5 m	1.0 m	1.5 m
WB	090-00002	6070	3.38	4.31	3.90	9.49	2.57	4.75	$F_{z,Rd}$	20.0	F_{Rd}		
FV	090-00001								25.0		9.5	3.7	1.6
									allow. F_z		allow. F		
									17.8		6.8	2.6	1.2

① F_z = max. load bearing capacity of the channel lips - see also page 66

Accessories

VUS 40/25

Washer

→ see page 56

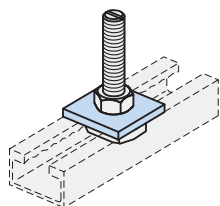

SIC 38/23

Locking washer

→ see page 56

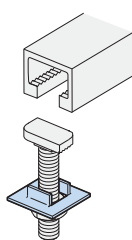

SDM - 36/6

Rubber vibration absorber

→ see catalogue MT-FFC

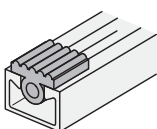

Further design properties

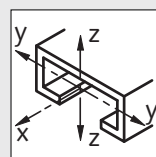

Cross section data
page 60

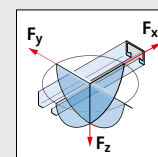

Point-load capacities
pages 66 - 67

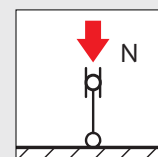

Flexural buckling
page 70

HALFEN FRAMING SYSTEMS

Framing Channels - Heavy Duty Framing System

Framing channel HZM 38/23

HZM 38/23 hot-rolled, serrated

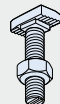

Suitable HALFEN Bolts HZS 38/23 and HS 38/17 → see page 32

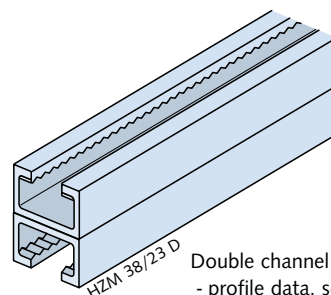
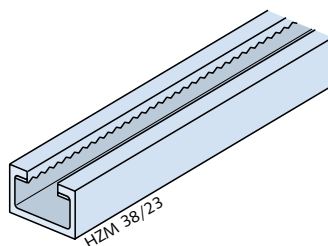
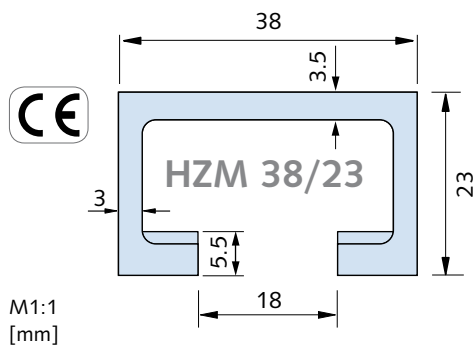

Double channel on request - profile data, see page 60

Dimensions and cross-section properties									Load capacities				
Material	Order no.	Length [mm]	Weight G [kg/m]	Cross section area A [cm ²]	Moment of inertia		Elastic section modulus		Max. point-load bearing capacity		Bending load capacity at span L		
					I_y [cm ⁴]	I_z [cm ⁴]	W_y [cm ³]	W_z [cm ³]	F_z [kN]	e_w [cm]	F [kN]		
											L [m]		
HZM 38/23	0284.								F_z ①	$\leq e_w$	0.5 m	1.0 m	1.5 m
WB	060-00001	6070	2.43	3.09	2.11	6.17	1.59	3.25	$F_{z,Rd}$	20	F_{Rd}		
FV	060-00003								18.0		5.9	2.0	0.9
A4	060-00002								allow. F_z		allow. F		
									12.8		4.2	1.4	0.6

① F_z = max. load bearing capacity of the channel lips - see also page 66

Accessories

VUS 40/25

Washer
→ see page 56

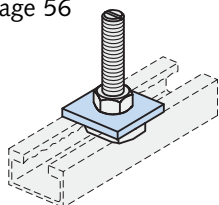

SIC 38/23

Locking washer
→ see page 56

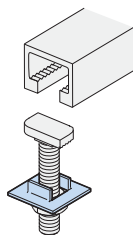

SDM - 36/6

Rubber vibration absorber
→ see catalogue MT-FFC

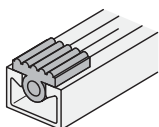

Further design properties

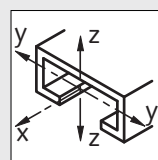

Cross section data
page 60

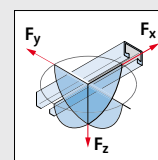

Point-load capacities
pages 66 - 67

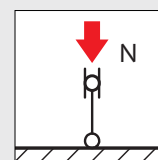

Flexural buckling
page 70

HALFEN FRAMING SYSTEMS

HALFEN Bolts – Heavy Duty Framing System

HALFEN Bolts HZS 38/23 and HS 38/17

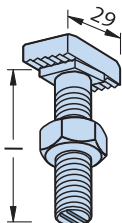

HZS 38/23
HALFEN Bolt
serrated incl. nut

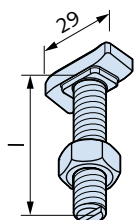

HS 38/17
HALFEN Bolt
incl. nut

Li = left-hand thread

High corrosion resistant steel HCR for HS 38/17 on request

HZS 38/23 available bolts					
Length l [mm]	M12	M16	Length l [mm]	M12	M16
30	GVs 8.8	GVs 8.8	80	GVs 8.8	GVs 8.8
40	GVs 8.8	GVs 8.8			
50	GVs 8.8	GVs 8.8	100	GVs 8.8	GVs 8.8
			125	GVs 8.8	GVs 8.8
60	GVs 8.8	GVs 8.8	150	GVs 8.8	GVs 8.8
			200	-	GVs 8.8
			300	-	GVs 8.8

HS 38/17 available bolts							
Length l [mm]	M10	M12	M16	Length l [mm]	M10	M12	M16
20	GVs 4.6	GVs 4.6	GVs 4.6 ①	60	GVs 4.6 A4-70	GVs 4.6 GVs 8.8 A4-70	GVs 4.6 GVs 8.8 FV 8.8 A4-50
25	-	A4-70	A4-50 ①				
30	GVs 4.6 FV 4.6 A4-70	GVs 4.6 FV 4.6 A2-70 A4-70	GVs 4.6 FV 4.6 A2-50 ① A4-50	70	-	FV 8.8	GVs 4.6 A4-50 ①
				80	GVs 4.6	GVs 4.6 A4-70	
40	GVs 4.6 A4-70	GVs 4.6 A2-70 A4-70	GVs 4.6 FV 4.6 A2-50 ① A4-50	80 Li	-	-	A4-50
				100	GVs 4.6	GVs 4.6 A4-50	GVs 4.6 FV 4.6 A4-50
50	GVs 4.6 A4-70	GVs 4.6 FV 4.6 A2-70 A4-70	GVs 4.6 FV 4.6 A2-50 ① A4-50	125	-	GVs 4.6	GVs 4.6
				150	GVs 4.6	GVs 4.6 A4-50 ①	GVs 4.6 A4-50
				200	-	GVs 4.6 A4-50 ①	GVs 4.6 A4-50 ①

① on request

Load bearing capacities for HALFEN Bolts ①

Thread Ø	Load capacities for HALFEN Bolts				Max. load capacity per bolt in channel longitudinal direction		Recommended torque				
	F [kN] ①				F _x [kN] ①		T _{inst} [Nm]				
38/23	HZS				HZS		HZS				
		8.8		A4-70	For all strength classes		8.8		A4-70		
	M12	F _{Rd}	27.2	-		16.8	80	-			
		allow. F	19.4	-		12.0					
M16	F _{Rd}	50.5		33.0		16.8	120	120			
		allow. F	36.1		23.6					12.0	
38/17	HS				HS		HS				
		4.6	8.8	A2-50; A4-50	A2-70; A4-70	-	4.6	8.8	A2-50; A4-50	A2-70; A4-70	
	M10	F _{Rd}	8.3	18.6	7.3	15.6	HALFEN Bolts HS are not suited for longitudinal loads!	15	40	15	30
			allow. F	5.9	13.3	5.2					
	M12	F _{Rd}	12.1	27.0	10.6	22.7		25	70	25	50
			allow. F	8.6	19.3	7.6					
	M16	F _{Rd}	22.6	50.2	19.8	42.2		65	180	60	130
			allow. F	16.1	35.9	14.1					

① Note: do not exceed the max. channel load bearing capacity

In case of simultaneously loading in all directions (longitudinal -x, transverse -y, central tension -z) the resultant load must not exceed the load bearing capacity given in the table.



$$\sqrt{F_x^2 + F_y^2 + F_z^2} \leq \text{allow. F}$$

resp.

$$\sqrt{F_{x,Ed}^2 + F_{y,Ed}^2 + F_{z,Ed}^2} \leq F_{Rd}$$

F_x, F_y, F_z = existing loads
allow. F = allowable load bearing capacity of the bolt

resp.
F_{x,Ed}, F_{y,Ed}, F_{z,Ed} = design values of action
F_{Rd} = design value of resistance

HALFEN FRAMING SYSTEMS

Framing Channels - Heavy Duty Framing System

Framing channel HZM 29/20

HZM 29/20 hot-rolled, serrated 

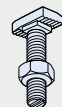
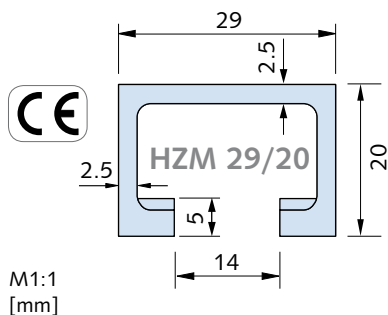

Suitable HALFEN Bolt HZS 29/20 and HS 28/15 → see page 34

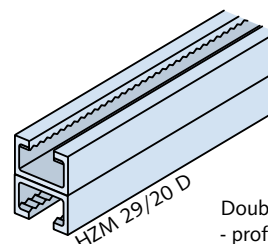
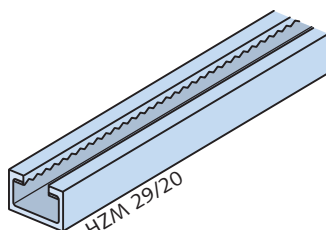

Double channel on request - profile data, see page 60

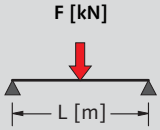
Dimensions and cross-section properties									Load capacities				
Material	Order no.	Length [mm]	Weight G [kg/m]	Cross section area A [cm ²]	Moment of inertia		Elastic section modulus		Max. point-load bearing capacity		Bending load capacity at span L		
					I_y [cm ⁴]	I_z [cm ⁴]	W_y [cm ³]	W_z [cm ³]	F_z ① [kN]	$\leq e_w$ [cm]	F [kN]		
HZM 29/20	0284.												
WB	050-00001	6070	1.55	1.98	1.02	2.42	0.91	1.67	$F_{z,Rd}$	15.0	F_{Rd}		
FV	050-00003								10.9		3.3	1.0	0.4
									allow. F_z		allow. F		
									7.8		2.4	0.7	0.3

① F_z = max. load bearing capacity of the channel lips - see also page 66

Accessories

US DIN 9021
Washer
→ see page 56

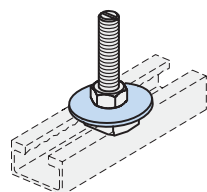

SIC 29/20
Locking washer
→ see page 56

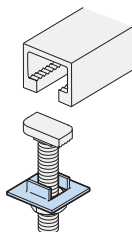

Further design properties

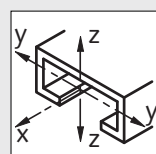

Cross section data
page 60

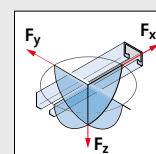

Point-load capacities
pages 66 - 67

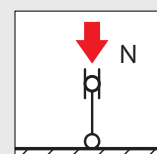

Flexural buckling
page 70

HALFEN FRAMING SYSTEMS

HALFEN Bolts – Heavy Duty Framing System

HALFEN Bolts HZS 29/20 and HS 28/15

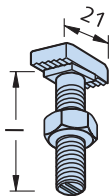

HZS 29/20
HALFEN Bolt
serrated incl. nut

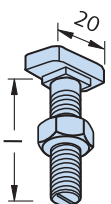

HS 28/15
HALFEN Bolt incl.
nut

High corrosion resistant stainless steel HCR for HS 28/15 on request

HZS 29/20 available bolts			
Length l [mm]	M12	Length l [mm]	M12
30	GVs 8.8	125	GVs 8.8
40	GVs 8.8	150	GVs 8.8
50	GVs 8.8	200	GVs 8.8
60	GVs 8.8	250	GVs 8.8
80	GVs 8.8	300	GVs 8.8
100	GVs 8.8		

HS 28/15 available bolts									
Length l [mm]	M6	M8	M10	M12	Length l [mm]	M6	M8	M10	M12
15	GVs 4.6	GVs 4.6	GVs 4.6		50		GVs 4.6	GVs 4.6	GVs 4.6
20	GVs 4.6	GVs 4.6	GVs 4.6					FV 4.6	GVs 4.6
		A2-70	A2-70				A2-70	A4-70	
25	GVs 4.6	GVs 4.6	GVs 4.6		60		GVs 4.6	GVs 4.6	
		A2-70	A2-70				GVs 8.8	A4-70	
30	GVs 4.6	GVs 4.6	GVs 4.6	GVs 4.6	80		GVs 4.6	GVs 4.6	GVs 4.6
		A2-70	FV 4.6				A4-70	A4-50	
		A4-70	A2-70		100		GVs 4.6	GVs 4.6	
		A4-70	A4-70					A4-50	
35				GVs 4.6	125			GVs 4.6	
								A4-50	
40	GVs 4.6	GVs 4.6	GVs 4.6		150		GVs 4.6	GVs 4.6	
			FV 8.8					A4-50	
			A2-70		200			GVs 4.6	
			A4-70					A4-50	

① on request

Load bearing capacities for HALFEN Bolts ①

Thread Ø	Load capacities for HALFEN Bolts				Max. load capacity per bolt in channel longitudinal direction		Recommended torque			
	 F [kN] ①				 Fx [kN] ①		 Tinst [Nm]			
29/20	HZS				HZS		HZS			
	8.8				8.8		8.8			
M12	F_{Rd}	27.2			11.2		80			
	allow. F	19.4			8.0					
28/15	HS				HS		HS			
		4.6	8.8	A2/A4-50	A2/A4-70	-	4.6	8.8	A2/A4-50	A2/A4-70
M6	F_{Rd}	2.9	-	-	-	HALFEN Bolts HS are not suited for longitudinal loads!	3	-	3	-
	allow. F	2.2	-	-	-		8	20	8	15
M8	F_{Rd}	5.3	11.7	-	-		15	40	15	30
	allow. F	4.0	8.3	-	5.5		25	70	25	50
M10	F_{Rd}	8.3	18.6	7.3	15.6					
	allow. F	6.4	13.3	5.2	11.2					
M12	F_{Rd}	12.1	-	-	-					
	allow. F	9.3	-	-	-					

① Note: do not exceed the max. channel load bearing capacity

In case of simultaneously loading in all directions (longitudinal -x, transverse -y, central tension -z) the resultant load must not exceed the load bearing capacity given in the table.

$$\sqrt{F_x^2 + F_y^2 + F_z^2} \leq \text{allow. F}$$

resp.

$$\sqrt{F_{x,Ed}^2 + F_{y,Ed}^2 + F_{z,Ed}^2} \leq F_{Rd}$$

F_x, F_y, F_z = existing loads
 allow. F = allowable load bearing capacity of the bolt
 resp.
 $F_{x,Ed}, F_{y,Ed}, F_{z,Ed}$ = design values of action
 F_{Rd} = design value of resistance

HALFEN FRAMING SYSTEMS

Framing Channels – Medium Duty Framing System

Framing channels HM 41/41 and HL 41/41

HM 41/41 resp. HL 41/41 cold-rolled

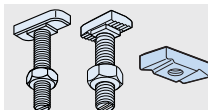
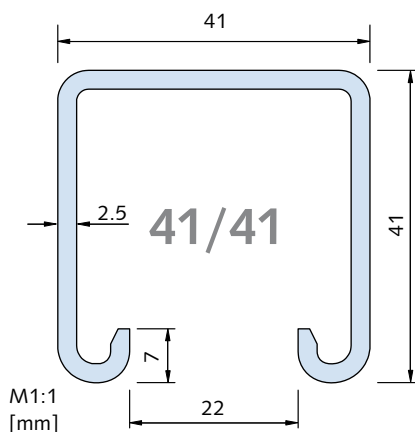

Suitable HALFEN Bolts HS 41/41, HZS 41/41, HZS 41/22 and locking plates → see pages 43 - 44

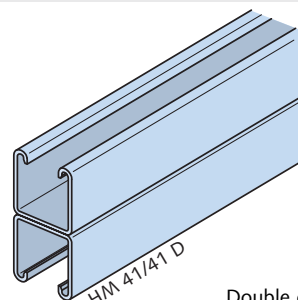
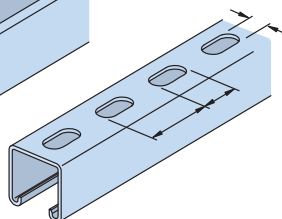
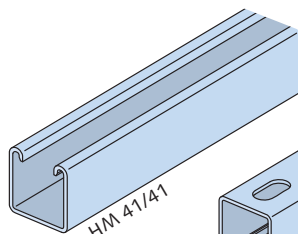

Double channel on request

Dimensions and cross-section properties									Load capacities									
Material	Order no.	Length	Weight	Cross section area	Moment of inertia		Elastic section modulus		Max. point-load bearing capacity	Bending load capacity at span L								
		[mm]	G [kg/m]	A [cm ²]	I_y [cm ⁴]	I_z [cm ⁴]	W_y [cm ³]	W_z [cm ³]	F_z [kN]	$\leq e_w$ [cm]	F [kN]							
											0.5 m	1.0 m	1.5 m					
HM 41/41	0280.	6000	2.67	3.4	7.47	9.44	3.24	4.57	7.8	49.0	7.8	3.9	2.6					
WB	080-00001													allow. F_z	5.6	5.6	2.8	1.9
SV	080-00002																	
FV	080-00003																	
A4	080-00004																	
HL 41/41	0281.	6000	2.46	2.98	6.07	9.16	2.84	4.43	7.8	42.0	6.6	3.2	2.2					
WB	010-00001													allow. F_z	5.6	4.7	2.3	1.6
SV	010-00003																	
FV	010-00002																	
A4	010-00004																	
HM 41/41 D	0280.	6000	5.34	6.81	37.60	18.88	9.10	9.14	7.8	132.0	10.6	7.1	5.3					
WB	150-00001													allow. F_z	5.6	7.6	5.1	3.8
FV	150-00003																	
A4	150-00002																	

① F_z = max. load bearing capacity of the channel lips

Accessories

HPE 41/41 Channel end cap → see page 58

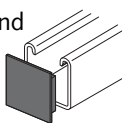

PA - 41 Channel cover → see page 58

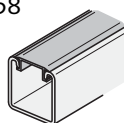

SDM - 41/8

Rubber vibration absorber → see catalogue MT-FFC

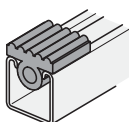

Further design properties

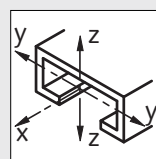

Cross section data pages 62, 64

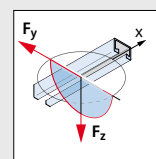

Point-load capacities page 68

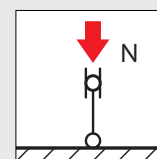

Flexural buckling page 71

HALFEN FRAMING SYSTEMS

Framing Channels – Medium Duty Framing System

Framing channel HZM 41/41 and HZL 41/41

HZM resp. HZL 41/41 cold-rolled, serrated

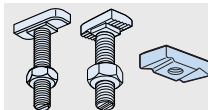

Suitable HALFEN Bolts HS 41/41, HZS 41/41, HZS 41/22 and locking plates → see pages 43 - 44

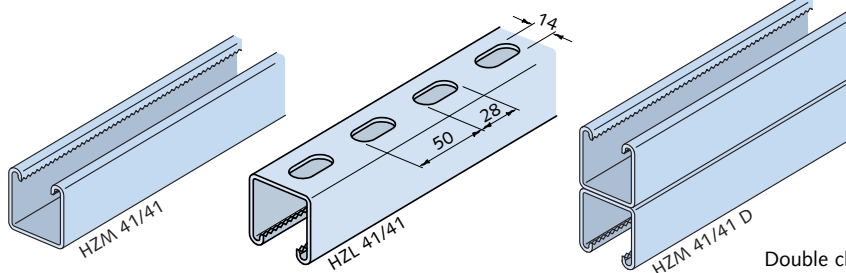
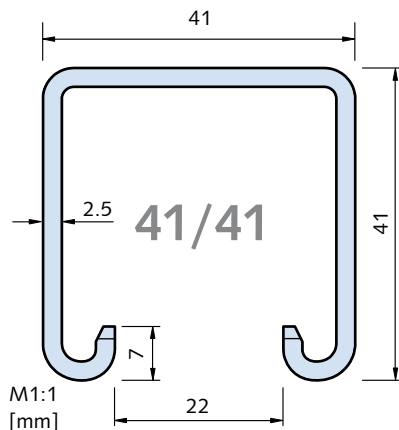

Double channel on request

Dimensions and cross-section properties									Load capacities				
Material	Order no.	Length	Weight	Cross section area	Moment of inertia		Elastic section modulus		Max. point-load bearing capacity		Bending load capacity at span L		
		[mm]	G [kg/m]	A [cm ²]	I _y [cm ⁴]	I _z [cm ⁴]	W _y [cm ³]	W _z [cm ³]	F _z ① [kN]	≤ e _w [cm]	F [kN]		
											0.5 m	1.0 m	1.5 m
HZM 41/41	0284.	6000	2.63	3.35	7.34	9.37	3.15	4.54	F _{z,Rd}	47.0	F _{Rd}		
WB	010-00001								7.8		7.7	3.8	2.6
FV	010-00002								allow. F _z		allow. F		
A4	010-00003								5.6		5.5	2.7	1.8
HZL 41/41	0283.	6000	2.46	2.90	5.87	9.04	2.69	4.38	F _{z,Rd}	41.0	0.5 m	1.0 m	1.5 m
WB	010-00001								F _{Rd}				
FV	010-00002								6.3		3.2	2.1	
A4	010-00003								allow. F _z		allow. F		
									5.6		4.5	2.3	1.5
HZM 41/41 D	0284.	6000	5.27	6.7	36.45	18.73	8.83	9.07	F _{z,Rd}	126.0	1.0 m	1.5 m	2.0 m
WB	030-00001								F _{Rd}				
FV	030-00002								10.3		6.9	5.2	
A4	030-00003								allow. F _z		allow. F		
									5.6		7.4	4.9	3.7

① F_z = max. load bearing capacity of the channel lips

Accessories

HPE 41/41

Channel end cap
→ see page 58

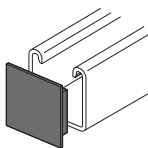

PA - 41 Channel cover
→ see page 58

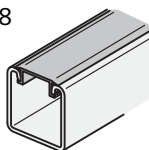

SDM - 41/8

Rubber vibration absorber
→ see catalogue MT-FFC

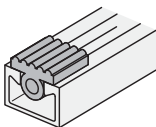

Further design properties

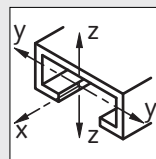

Cross section data
pages 62, 64

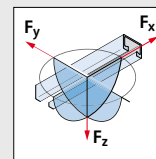

Point-load capacities
page 68

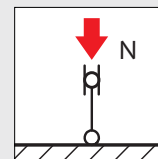

Flexural buckling
page 71

HALFEN FRAMING SYSTEMS

Framing Channels – Medium Duty Framing System

Framing channel HM 41/62 and HL 41/62

HM resp. HL 41/62 cold-rolled

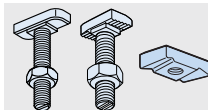
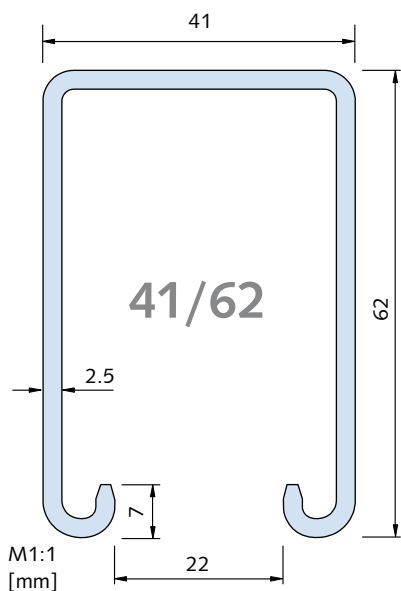

Suitable HALFEN Bolts HS 41/41, HZS 41/41, HZS 41/22 and locking plates → see pages 43 - 44

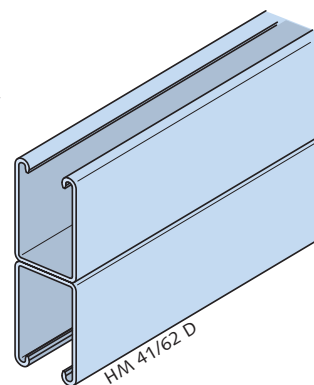
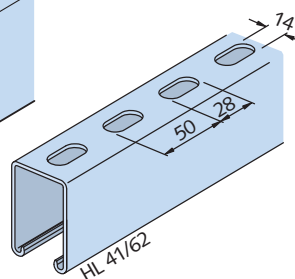
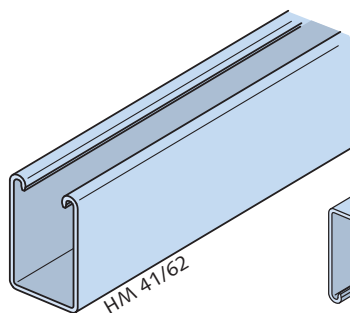

Note on span L: take constructive measures to prevent failure caused by bulging, tilting and buckling

Double channel on request

Dimensions and cross-section properties									Load capacities				
Material	Order no.	Length [mm]	Weight [kg/m]	Cross section area [cm ²]	Moment of inertia		Elastic section modulus		Max. point-load bearing capacity		Bending load capacity at span L		
			G	A	I _y	I _z	W _y	W	F _z ①	≤ e _w	F [kN]		
					[cm ⁴]	[cm ⁴]	[cm ³]	[cm ³]	[kN]	[cm]	1.0 m	2.0 m	3.0 m
HM 41/62	0280.												
WB	140-00002	6000	3.48	4.44	20.96	13.34	6.21	6.46	F _{z,Rd}	92.0	F _{Rd}		
									7.8		7.4	3.7	2.2
FV	140-00003								allow. F _z			allow. F	
									5.6		5.3	2.6	1.6
HL 41/62	0281.												
WB	040-00001	6000	3.14	3.99	17.27	13.03	5.47	6.31	F _{z,Rd}	81.0	F _{Rd}		
SV	040-00003												
FV	040-00002												
											6.3	3.1	1.8
											allow. F		
											4.5	2.2	1.3
HM 41/62 D	0280.												
WB	170-00001	6000	6.97	8.88	112.88	26.68	18.21	12.92	F _{z,Rd}	269.0	F _{Rd}		
FV	170-00002												
											21.4	14.3	10.7
											allow. F		
											15.3	10.2	7.7

① F_z = max. load bearing capacity of the channel lips

Accessories: PA - 41 Channel cover, see page 58; SDM - 41/8 Rubber vibration absorber, see Technical Product Information: "HALFEN Flexible Framing Connections" MT-FFC.

Further design properties: Cross section data → pages 62, 64

HALFEN FRAMING SYSTEMS

Framing Channels – Medium Duty Framing System

Framing channel HM 41/83 and HL 41/83

HM 41/83 resp. HL 41/83 cold-rolled

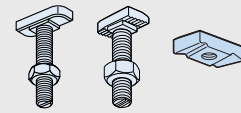
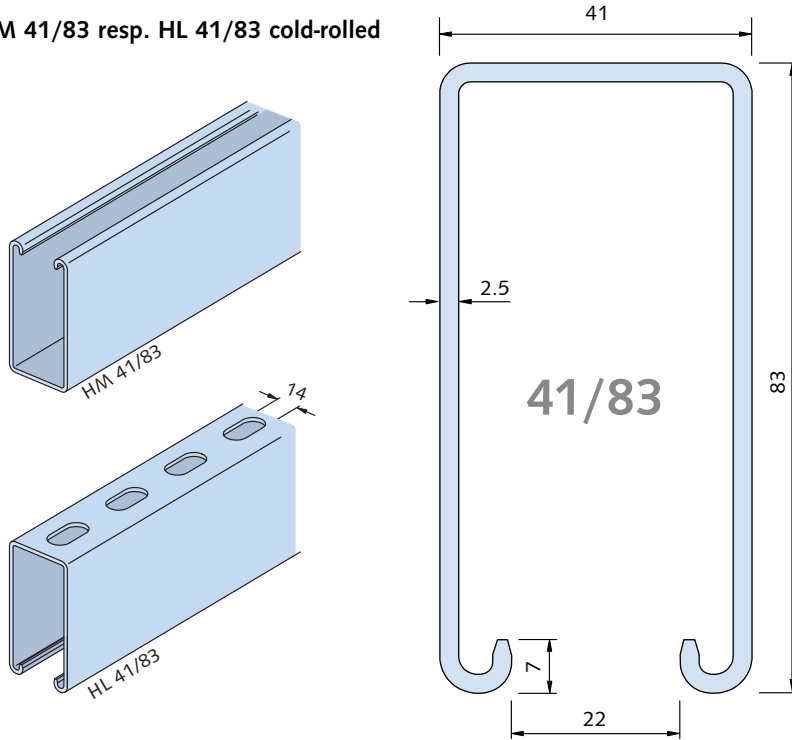

Suitable HALFEN Bolts HS 41/41, HZS 41/41, HZS 41/22 and locking plates → see pages 43 - 44

Further design properties

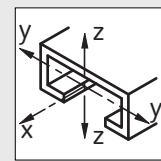

Cross section data pages 62, 64



Note on span L: take constructive measures to prevent failure caused by bulging, tilting and buckling

Dimensions and cross-section properties									Load capacities				
Material	Order no.	Length [mm]	Weight G [kg/m]	Cross section area A [cm ²]	Moment of inertia [cm ⁴]		Elastic section modulus [cm ³]		Max. point-load bearing capacity	Bending load capacity at span L			
					I_y	I_z	W_y	W_z	F_z ① [kN]	$\leq e_w$ [cm]	F [kN]		
											1.0 m	2.0 m	3.0 m
HM 41/83	0280.	6000	4.29	5.47	43.82	17.22	9.91	8.34	$F_{z,Rd}$	148.0	F_{Rd}		
WB	130-00002								7.8		11.7	5.9	3.9
SV	130-00001								allow. F_z		allow. F		
FV	130-00003								5.6		8.4	4.2	2.8
HL 41/83	0281.	6000	3.93	5.02	37.07	16.93	8.85	8.20	$F_{z,Rd}$	133.0	1.0 m	2.0 m	3.0 m
WB	030-00004								F_{Rd}				
SV	030-00006								10.2		5.2	3.4	
FV	030-00005								allow. F_z		allow. F		
											7.3	3.7	2.4

① F_z = max. load bearing capacity of the channel lips

Accessories

PA - 41
Channel cover
→ see page 58

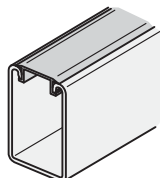

SDM - 41/8
Rubber vibration absorber
→ see catalogue MT-FFC

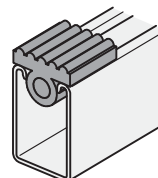

HALFEN FRAMING SYSTEMS

Framing Channels – Medium Duty Framing System

Framing channel HZL 63/63

HZL 63/63 cold-rolled, serrated 

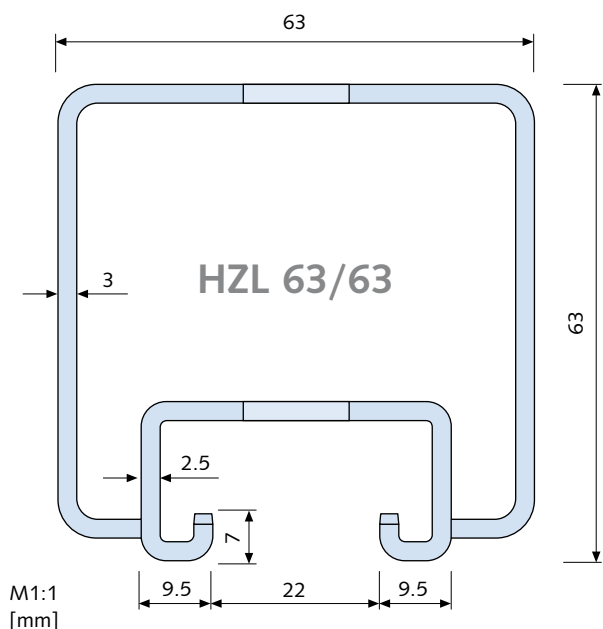

Standard profile for HALFEN Powerclick System 63. More information on the HALFEN Framing System "Powerclick" can be found in Technical Product Information "HALFEN Powerclick PC63".

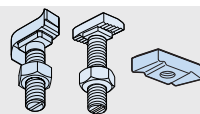

Suitable HALFEN Bolts HS 41/41, HZS 41/41, HZS 41/22 and locking plates → see pages 43 - 44

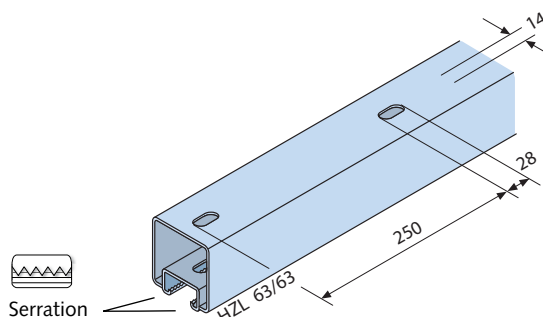

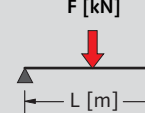
Dimensions and cross-section properties								Load capacities						
Material	Order no.	Length [mm]	Weight G [kg/m]	Cross section area A [cm ²]	Moment of inertia		Elastic section modulus		Max. point-load bearing capacity		Bending load capacity at span L			
					I_y [cm ⁴]	I_z [cm ⁴]	W_y [cm ³]	W_z [cm ³]	F_z ① [kN]	$\leq e_w$ [cm]	 F [kN] L [m]			
HZL 63/63	0283.													
FV	030-00001	3000	6.35	7.09	33.07	42.95	10.06	13.63	$F_{z,Rd}$	134.0	F_{Rd}			
		7.8							23.1		11.5	7.7		
FV	030-00003	6000							allow. F_z		allow. F			
									5.6		16.5	8.2	5.5	

① F_z = max. load bearing capacity of the channel lips

Accessories

HPE 63/63

Channel end cap
→ see page 58

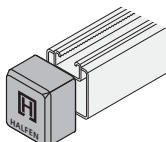

PA - 41

Channel cover
→ see page 58

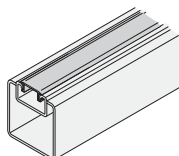

SDM - 41/8

Rubber vibration absorber
→ see catalogue MT-FFC

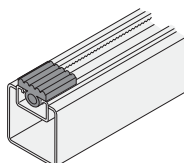

Further design properties

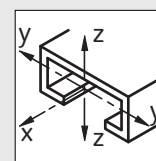

Cross section data
page 64

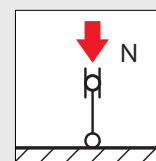

Flexural buckling
page 71

HALFEN FRAMING SYSTEMS

Framing Channels – Medium Duty Framing System

Framing channel HM 41/22 and HL 41/22

HM 41/22 resp. HL 41/22 cold-rolled

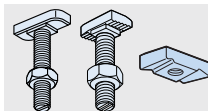
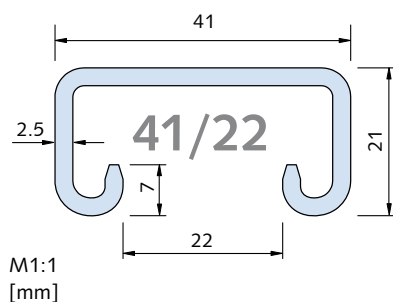

Suitable HALFEN Bolts HS 41/41, HZS 41/41, HZS 41/22 and locking plates → see pages 43 - 44

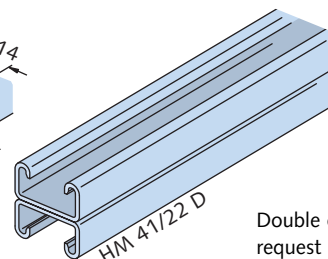
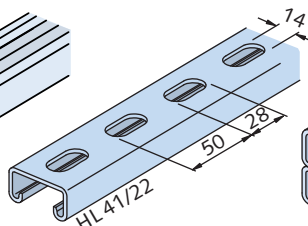
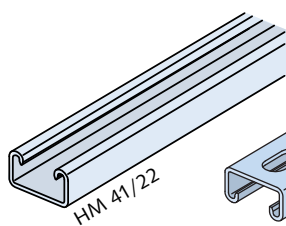

Double channel on request

Dimensions and cross-section properties									Load capacities				
Material	Order no.	Length	Weight	Cross section area	Moment of inertia		Elastic section modulus		Max. point-load bearing capacity		Bending load capacity at span L		
		[mm]	G [kg/m]	A [cm ²]	I _y [cm ⁴]	I _z [cm ⁴]	W _y [cm ³]	W _z [cm ³]	F _z ① [kN]	≤ e _w [cm]	F [kN] L [m]		
HM 41/22	0280.	6000	1.86	2.37	1.28	5.56	1.05	2.69	F _z	15.0	0.5 m	1.0 m	1.5 m
WB	120-00001								F _{z,Rd}		F _{Rd}		
SV	120-00002								7.8		2.7	1.2	0.5
FV	120-00003								allow. F _z		allow. F		
A4	120-00004								5.6		1.9	0.9	0.4
HL 41/22	0281.	6000	1.57	1.95	0.99	5.27	0.89	2.55	F _z	12.0	0.5 m	1.0 m	1.5 m
WB	020-00001								F _{z,Rd}		F _{Rd}		
SV	020-00003								7.8		2.2	1.0	0.4
FV	020-00002								allow. F _z		allow. F		
A4	020-00004								5.6		1.6	0.7	0.3
HM 41/22 D	0280.	6000	3.73	4.75	6.02	11.11	2.91	5.38	F _z	42.0	1.0 m	1.5 m	2.0 m
WB	160-00001								F _{z,Rd}		F _{Rd}		
FV	160-00002								7.8		3.5	2.3	1.4
A4	160-00003								allow. F _z		allow. F		
									5.6		2.5	1.7	1.0

① F_z = max. load bearing capacity of the channel lips

Accessories

HPE 41/22
Channel end cap
→ see page 58

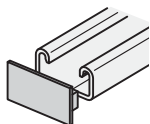

PA - 41
Channel cover
→ see page 58

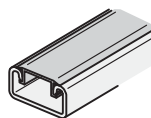

SDM - 41/8
Rubber vibration absorber
→ see catalogue MT-FFC

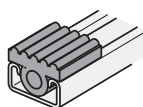

Further design properties

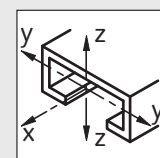

Cross section data
pages 62, 64

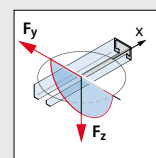

Point-load capacities
page 68

HALFEN FRAMING SYSTEMS

Framing Channels – Medium Duty Framing System

Framing channel HZM 41/22 and HZL 41/22

HZM resp. HZL 41/22 cold-rolled, serrated

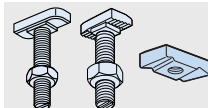

Suitable HALFEN Bolts HS 41/41, HZS 41/41, HZS 41/22 and locking plates → see pages 43 - 44

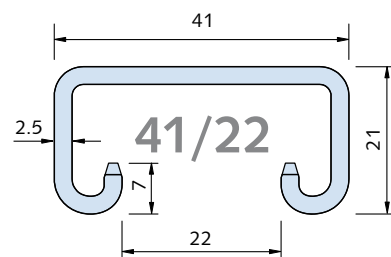

M1:1
[mm]

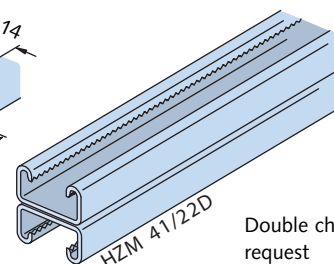
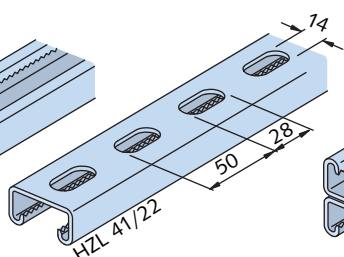
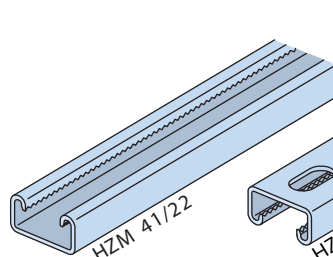

Double channel on request

Dimensions and cross-section properties									Load capacities				
Material	Order no.	Length [mm]	Weight G [kg/m]	Cross section area A [cm ²]	Moment of inertia		Elastic section modulus		Max. point-load bearing capacity		Bending load capacity at span L		
					I_y [cm ⁴]	I_z [cm ⁴]	W_y [cm ³]	W_z [cm ³]	F_z ① [kN]	e_w [cm]			
HZM 41/22	0284.	6070	1.83	2.33	1.26	5.48	1.03	2.66	$F_{z,Rd}$	14.0	F_{Rd}		
WB	020-00001								7.8		2.7	1.2	0.5
FV	020-00002								allow. F_z		allow. F		
A4	020-00003								5.6		1.9	0.8	0.4
HZL 41/22		6000	1.57	1.87	0.97	5.15	0.86	2.49	$F_{z,Rd}$	12.0	F_{Rd}		
WB	020-00001								7.8		2.1	0.8	0.4
FV	020-00002								allow. F_z		allow. F		
A4	020-00003								5.6		1.5	0.6	0.3
HZM 41/22 D		6070	3.58	4.65	5.83	10.97	2.82	5.31	$F_{z,Rd}$	42.0	1.0 m	1.5 m	2.0 m
WB	040-00001								F_{Rd}				
FV	040-00002								3.4		2.2	1.4	
A4	040-00003								allow. F_z		allow. F		
									5.6		2.4	1.6	1.0

① F_z = max. load bearing capacity of the channel lips

Accessories

HPE 41/22

Channel end cap
→ see page 58

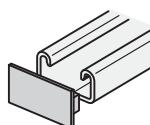

PA - 41

Channel cover
→ see page 58

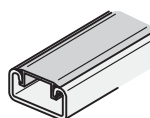

SDM - 41/8

Rubber vibration absorber
→ see catalogue MT-FFC

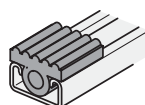

Further design properties

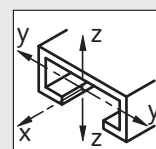

Cross section data
pages 62, 64

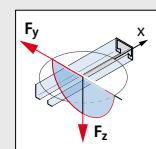

Point-load capacities
page 68

HALFEN FRAMING SYSTEMS

Framing Channels – Medium Duty Framing System

Framing channel HLL 41/41 and HLL 41/22

HLL 41/41 cold-rolled

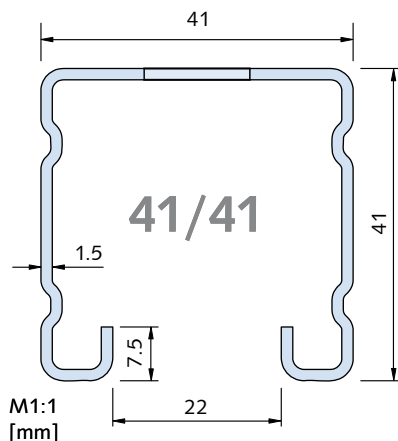

HLL 41/22 cold-rolled

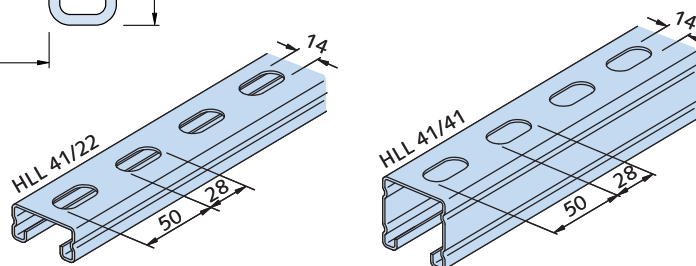
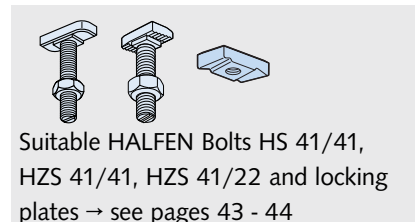
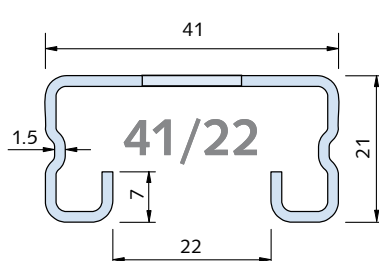

Dimensions and cross-section properties									Load capacities					
Material	Order no.	Length [mm]	Weight [kg/m]	Cross section area [cm ²]	Moment of inertia		Elastic section modulus		Max. point-load bearing capacity		Bending load capacity at span L			
			G	A	I _y	I _z	W _y	W _z	F _z ①	≤ e _w	F [kN]			
					[cm ⁴]	[cm ⁴]	[cm ³]	[cm ³]	[kN]	[cm]	0.5 m	1.0 m	1.5 m	
HLL 41/41	0282.	[mm]	[kg/m]	[cm ²]	I _y	I _z	W _y	W _z	F _z ①	≤ e _w	F [kN]			
SV	010-00002	6000	1.61	1.92	4.24	6.10	2.04	2.95	F _{z,Rd}	91.0	F _{Rd}			
									2.5			4.5	2.2	1.4
									allow. F _z			allow. F		
									1.8		3.2	1.6	1.0	
HLL 41/22	0282.													
SV	020-00003	6000	1.14	1.33	0.75	3.67	0.71	1.78	F _{z,Rd}	31.0	F _{Rd}			
									2.5			1.54	0.56	0.28
									allow. F _z			allow. F		
									1.8		1.1	0.4	0.2	

① F_z = max. load bearing capacity of the channel lips

Accessories

HPE 41/41 resp. HPE 41/22

Channel end cap
→ see page 58

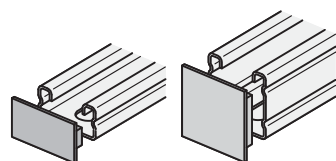

PA - 41 Channel cover

→ see page 58

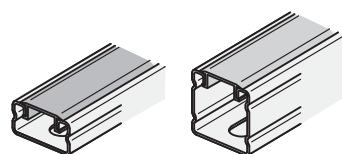

SDM - 41/8

Rubber vibration absorber
→ see catalogue MT-FFC

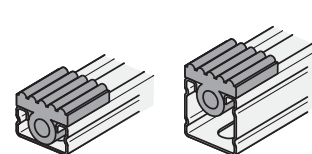

HALFEN FRAMING SYSTEMS

Framing Channels – Medium Duty Framing System

HALFEN Bolts HZS 41/41, HZS 41/22 and HS 41/41

HALFEN Bolts for all 41/... channels:

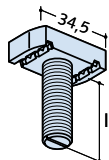

HZS 41/41
HALFEN Bolt serrated,
order nut separately

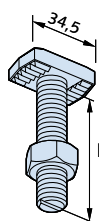

HZS 41/22
HALFEN Bolt serrated,
incl. nut
for serrated channels
41/41, 41/22 and
63/63

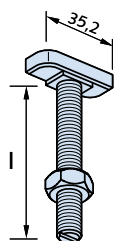

HS 41/41
HALFEN Bolt
incl. nut

HZS 41/41 available bolts					
Length l [mm]	M6	M8	M10	M12	M16 ^{①②}
30	ZL	ZL	ZL	ZL	-
50	-	ZL	ZL	ZL	-
63	-	-	-	-	ZL
75	-	-	ZL	ZL	-
100	-	-	-	ZL FV4.6	-
102	-	-	-	-	ZL

① Diameter M16 is not compatible with profile 41/22
② Diameter M16 can only be inserted into the slot from channel end
ZL = zinc flake coating

HZS 41/22 available bolts		
Length l [mm]	M12	M16
35	FV 8.8 A4-50	A4-50 -
50	FV 8.8 A4-50	FV 8.8 A4-50
80	A4-50	-
100	-	FV 8.8

HS 41/41 available bolts		
Length l [mm]	M10	M12
35	FV 4.6 A4-70	FV 4.6 A4-70
50	-	FV 4.6

Torques for HALFEN Bolts^①

41/...	Thread Ø	Recommended torques T_{inst} [Nm]				
		HZS 41/41 steel	HZS 41/22 8.8	HZS 41/22 A4-50	HS 41/41 4.6	HS 41/41 A4-70
	M6	12	-	-	-	-
	M8	28	-	-	-	-
	M10	55	-	-	15	15
	M12	60 (55)	50	50	25	25
	M16	125 (95)	80	80	-	-

() values for HLL profiles in brackets

Load capacities for 41/... HALFEN Bolts

Thread Ø	41/...	Load bearing capacities per bolt for centric tension for all 41/... and 63/... profiles F_z [kN]					Recommended load capacity per HALFEN Bolt in channel longitudinal direction F_x [kN]					
		HZS 41/41 steel	HZS 41/22 8.8	HZS 41/22 A4-50	HS 41/41 4.6	HS 41/41 A4-70	For profiles HZM/HZL 41/22, 41/41, 63/63		For profiles HM/HL 41/22, 41/41, 41/62, 41/83		For profiles HLL 41/22, 41/41	
M6	F_{Rd}	7.0	-	-	-	-	3.1	-	-	1.4	-	1.4
	allow. F	5.0	-	-	-	-	2.2	-	-	1.0	-	1.0
M8	F_{Rd}	8.4	-	-	-	-	5.6	-	-	3.4	-	3.4
	allow. F	6.0	-	-	-	-	4.0	-	-	2.4	-	2.4
M10	F_{Rd}	9.8	-	-	9.0	9.0	7.0	-	-	4.9	-	4.9
	allow. F	7.0	-	-	6.4	6.4	5.0	-	-	3.5	-	3.5
M12	F_{Rd}	9.8	9.8	9.8	11.2	13.0	7.0	7.0	7.0	5.6	2.4	5.0
	allow. F	7.0	7.0	7.0	8.0	9.3	5.0	5.0	5.0	4.0	1.7	3.6
M16	F_{Rd}	16.8 ^{①②}	9.8	16.8	-	-	5.6 ^{①②}	7.0	7.0	5.6 ^{①②}	5.6	5.6 ^{①②}
	allow. F	12.0 ^{①②}	7.0	12.0	-	-	4.0 ^{①②}	5.0	5.0	4.0 ^{①②}	4.0	4.0 ^{①②}

① Diameter M16 is not compatible with profile 41/22
② Diameter M16 can only be inserted into the slot from channel end
③ HZS 41/41 M16 × 102 without serration

HALFEN FRAMING SYSTEMS

Framing Channels – Medium Duty Framing System

Locking plates GWP 41/41 - SN, - SH, GWP 41/22

GWP 41/41

Locking plate for all 41/... channels and profile 63/63

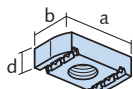

GWP 41/41 SH

Locking plate with long spring for channel 41/41

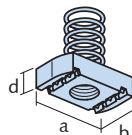

GWP 41/41 SN

Locking plate with short spring for channels 41/22 and 63/63

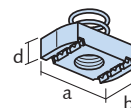

GWP 41/41 available plates

FV	GV	A4	d [mm]	b [mm]	a [mm]
-	M6	M6	6	20	34.5
M8	M8	M8	8/6		
M10	M10	M10	9		
FM12	FM12	FM12	12	30	
M12	M12	-			
M16	-	M16			

F = flat shape, fits to all flat 41/.. and 63/.. profiles

GWP 41/41 SH available plates

GV	d [mm]	b [mm]	a [mm]
GV	6	20	34,5
M6	6		
M8	8		
M10	9		
M12	12		

GWP 41/41 SN available plates

GV	d [mm]	b [mm]	a [mm]
GV	6	20	34,5
M6	6		
M8	8		
M10	9		
F M12			

F = flat shape, fits to all 41/.. and 63/.. profiles

GWP 41/22

Locking plate for serrated channel 41/22 and 41/41

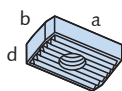

GWP 41/22 available plates

GV	A4	d [mm]	b [mm]	a [mm]
GV	A4	7.5	20	34.5
M6	-			
M8	M8			
M10	M10			
M12	M12			
M16	M16			

Torques for 41/... locking plates

Thread Ø	Recommended torques T _{inst} [Nm]			
	GWP 41/41 steel	GWP 41/41 A4	GWP 41/22 steel	GWP 41/22 A4
M6	12	6.5	12	6.5
M8	28	16.0	28	16.0
M10	55	31.5	55	31.5
M12	75 (55)	-	50	50
FM12	60 (55)	55	-	-
M16	125 (95)	125	80	80

() values for HLL profiles in brackets

Load capacities for 41/... locking plates

Thread Ø		Load bearing capacities for centric tension for all 41/... and 63/... profiles F _z [kN]				Recommended load capacity for locking plates in channel longitudinal direction F _x [kN]					
		GWP 41/41 steel	GWP 41/41 A4	GWP 41/22 steel	GWP 41/22 A4	GWP 41/41 steel	GWP 41/41 A4	GWP 41/22 steel	GWP 41/22 A4	GWP 41/41 steel	GWP 41/41 steel
41/...	F _{Rd}	7.0	7.0	7.0	7.0	3.1	3.1	3.1	-	1.4	1.4
	allow. F	5.0	5.0	5.0	5.0	2.2	2.2	2.2	-	1.0	1.0
M6	F _{Rd}	8.4	8.4	8.4	8.4	5.6	5.6	5.6	5.6	3.4	3.4
	allow. F	6.0	6.0	6.0	6.0	4.0	4.0	4.0	4.0	2.4	2.4
M8	F _{Rd}	9.8	9.8	9.8	9.8	7.0	7.0	7.0	7.0	4.9	4.9
	allow. F	7.0	7.0	7.0	7.0	5.0	5.0	5.0	5.0	3.5	3.5
M10	F _{Rd}	12.6 ①	-	9.8	9.8	7.0 ①	-	7.0	7.0	7.0	5.0
	allow. F	9.0 ①	-	7.0	7.0	5.0 ①	-	5.0	5.0	5.0	3.6
FM12	F _{Rd}	9.8	9.8	-	-	7.0	7.0	-	-	5.6	5.0
	allow. F	7.0	7.0	-	-	5.0	5.0	-	-	4.0	3.6
M16 ①②	F _{Rd}	16.8 ①②	9.8 ①②	9.8	9.8	10.5 ①②	7.0 ①②	10.5	7.0	10.5 ①②	6.3 ①②
	allow. F	12.0 ①②	7.0 ①②	7.0	7.0	7.5 ①②	5.0 ①②	7.5	5.0	7.5 ①②	4.5 ①②

F = flat shape, fits to all standard 41/.. and 63/.. profiles

① Not compatible with profiles 41/22 and 63/63

② Diameter M16 can only be inserted into the slot from channel end

HALFEN FRAMING SYSTEMS

Framing Channels – Light Duty Framing Systems

Framing channel HM 36/36, HL 36/36 and HM 38/17

HM 36/36 resp. HL 36/36 cold-rolled

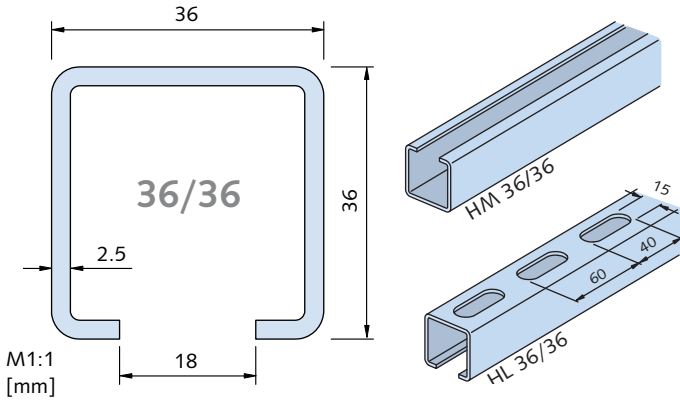

HM 38/17 cold-rolled

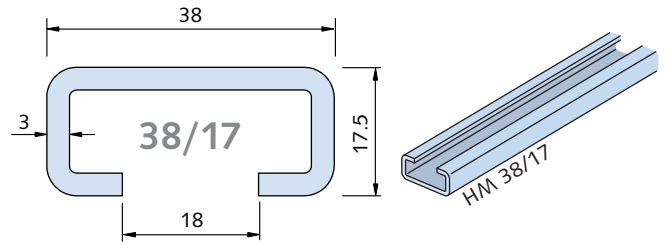

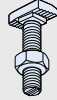
 Suitable HALFEN Bolts
HS 38/17 → see page 46

Dimensions and cross-section properties									Load capacities				
Material	Order no.	Length [mm]	Weight [kg/m]	Cross section area [cm ²]	Moment of inertia [cm ⁴]		Elastic section modulus [cm ³]		Max. point-load bearing capacity		Dending load capacity at span L		
					I_y	I_z	W_y	W_z	F_z ① [kN]	e_w [cm]	F [kN]		
											L [m]		
HM 36/36	0280.	6000	2.2	2.80	4.54	5.89	2.19	3.27	$F_{z,Rd}$	44	F_{Rd}		
WB	070-00001								6.2		5.5	2.7	1.8
FV	070-00002								allow. F_z		allow. F		
A4	070-00003								4.4		3.9	1.9	1.3
HL 36/36	0281.	6000	2.0	2.42	3.65	5.78	1.97	3.21	$F_{z,Rd}$	36	F_{Rd}		
WB	050-00001								6.2		4.5	2.2	1.5
FV	050-00002								allow. F_z		allow. F		
A4	050-00003								4.4		3.2	1.6	1.1
HM 38/17	0290.	6070	1.78	2.27	0.84	4.13	0.80	2.20	$F_{z,Rd}$	11	F_{Rd}		
WB	020-00001								6.7		2.10	0.84	0.42
FV	020-00002								allow. F_z		allow. F		
A2 ②	020-00003								4.8		1.5	0.6	0.3
A4	020-00004												

① F_z = max. load bearing capacity of the channel lips

② Stainless steel A2 on request; Note: high corrosion resistant stainless steel HCR for HM 38/17 on request

Accessories

PA 18 H Channel cover → see page 58

HPE 36/36 Channel end cap for HM and HL 36/36

→ see page 58

SIC 38/17 Locking washer → see page 56

SDM - 36/6 Rubber vibration absorber → see catalogue MT-FFC

Further design properties

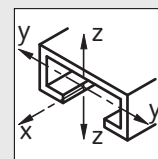

Cross section data
pages 62, 64

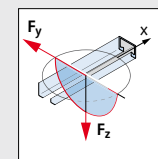

Point-load capacities
page 68

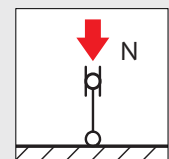

Flexural buckling
page 71

HALFEN FRAMING SYSTEMS

HALFEN Bolts - Light Duty Framing Systems

HALFEN Bolts HS 38/17

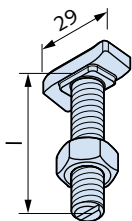

HS 38/17

HALFEN Bolt
incl. nut

Li = left-hand thread

High corrosion resistant stainless steel
HCR on request

HS 38/17 available bolts

Length l [mm]	M10	M12	M16	Length l [mm]	M10	M12	M16	
20	GVs 4.6	GVs 4.6	GVs 4.6 ①	60	GVs 4.6 A4-70	GVs 4.6 GVs 8.8 A4-70	GVs 4.6 GVs 8.8 FV 8.8 A4-50	
25		A4-70	A4-50 ①					
30	GVs 4.6 FV 4.6 A4-70	GVs 4.6 FV 4.6 A2-70 A4-70	GVs 4.6 FV 4.6 A2-50 ① A4-50	70		FV 8.8		
	40	GVs 4.6 A4-70	GVs 4.6 A2-70 A4-70	GVs 4.6 FV 4.6 A2-50 ① A4-50	80	GVs 4.6	GVs 4.6 A4-70	GVs 4.6 A4-50 A4-70 ①
50		GVs 4.6 A4-70	GVs 4.6 FV 4.6 A2-70 A4-70	GVs 4.6 FV 4.6 A4-50	80 Li			A4-50
	100				100	GVs 4.6	GVs 4.6 A4-50	GVs 4.6 FV 4.6 A4-50
		125				125		GVs 4.6
150					150	GVs 4.6	GVs 4.6 A4-50 ①	GVs 4.6 A4-50
	200						GVs 4.6 A4-50 ①	GVs 4.6 A4-50 ①

① on request

Load bearing capacities for HALFEN Bolts ①

Thread Ø	Load capacities for HALFEN Bolts				Recommended load bearing capacities per HALFEN Bolt in channel longitudinal direction			Recommended torques				
	F [kN]				F _x [kN] ②			T _{inst} [Nm]				
38/17	HS				HS			HS				
	4.6	8.8	A2-50 A4-50	A2-70 A4-70	4.6	8.8	A2-50; A4-50; A2-70; A4-70	4.6	8.8	A2-50; A4-50	A2-70; A4-70	
M10	F _{Rd}	8.3	18.6	7.3	15.6	0.42	1.54	0.42	15	40	15	30
	allow. F	5.9	13.3	5.2	11.2	0.3	1.1	0.3				
M12	F _{Rd}	12.1	27.0	10.6	22.7	0.7	2.2	0.7	25	70	25	50
	allow. F	8.6	19.3	7.6	16.2	0.5	1.6	0.5				
M16	F _{Rd}	22.6	50.2	19.8	42.2	1.3	4.2	1.26	65	180	60	130
	allow. F	16.1	35.9	14.1	30.2	0.9	3.0	0.9				

① Note: do not exceed the max. channel load bearing capacity!

② Load capability due to friction

Locking plates

GWP 38/17

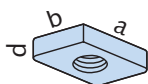

GWP 38/17 available bolts

GV	A4	a [mm]	b [mm]	d [mm]
M6	M6	33.5	17.5	6
M8	M8			
M10	M10			
M12	M12			

Load capacities GWP 38/17

Thread	Load capacity [kN]	
	F _{Rd}	allow. F
M6	F _{Rd}	3.1
	allow. F	2.2
M8	F _{Rd}	5.6
	allow. F	4.0
M10	F _{Rd}	8.0
	allow. F	5.7
M12	F _{Rd}	8.0
	allow. F	5.7

HALFEN FRAMING SYSTEMS

Framing Channels – Light Duty Framing Systems

Framing channels HM 28/28 and HL 28/28

HM 28/28 resp. HL 28/28 cold-rolled



Suitable HALFEN Bolts
HS 28/15 → see page 51

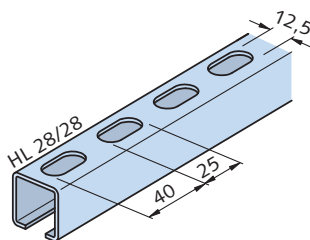
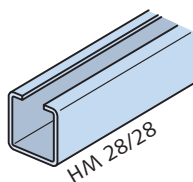
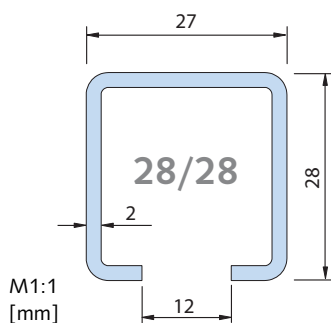

Dimensions and cross-section properties								Load capacities					
Material	Order no.	Length [mm]	Weight G [kg/m]	Cross section area A [cm ²]	Moment of inertia		Elastic section modulus		Max. point-load bearing capacity	Bending load capacity at span L			
					I_y [cm ⁴]	I_z [cm ⁴]	W_y [cm ³]	W_z [cm ³]	F_z ① [kN]	$\leq e_w$ [cm]	F [kN] L [m]		
HM 28/28	0280.	6000	1.36	1.73	1.70	2.01	1.08	1.49	$F_{z,Rd}$	31.0	F_{Rd}		
WB	050-00001								4.2		2.7	1.3	0.7
SV	050-00003								allow. F_z		allow. F		
FV	050-00002								3.0		1.9	0.9	0.5
A4	050-00004												
HL 28/28	0281.	6000	1.22	1.48	1.33	1.98	0.95	1.47	$F_{z,Rd}$	25.5	F_{Rd}		
WB	060-00001								4.2		2.10	1.12	0.56
SV	060-00003								allow. F_z		allow. F		
FV	060-00002								3.0		1.5	0.8	0.4
A4	060-00004												

① F_z = max. load bearing capacity of the channel lips

Accessories

HPE 28/28

Channel end cap
→ see page 58

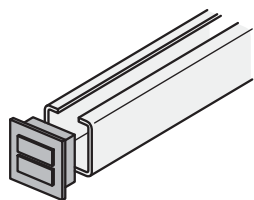

SDM - 28/6

Rubber vibration absorber
→ see catalogue MT-FFC

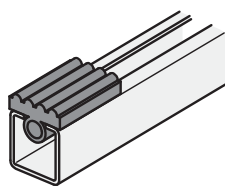

Further design properties

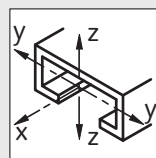

Cross section data
pages 62, 64

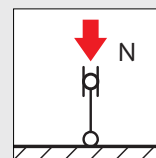

Flexural buckling
page 71

HALFEN FRAMING SYSTEMS

Framing Channels – Light Duty Framing Systems

Framing channel HM 26/26 and HL 26/26

HM 26/26 resp. HL 26/26 cold-rolled

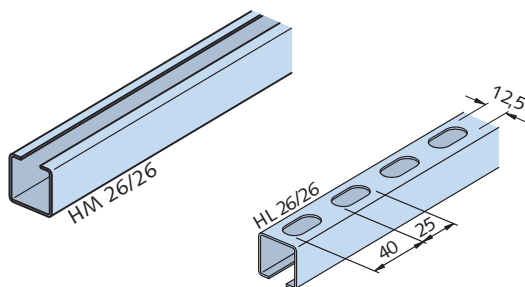
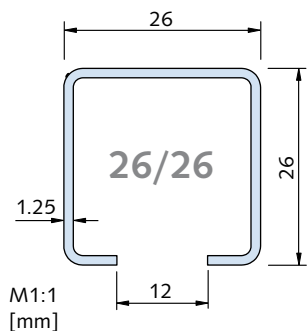

Suitable HALFEN Bolts
HS 28/15 → see page 51

Dimensions and cross-section properties									Load capacities				
Material	Order no.	Length	Weight	Cross section area	Moment of inertia		Elastic section modulus		Max. point-load bearing capacity	Bending load capacity at span L			
		[mm]	[kg/m]	A [cm ²]	I _y [cm ⁴]	I _z [cm ⁴]	W _y [cm ³]	W _z [cm ³]	F _z ① [kN]	≤ e _w [cm]	F [kN]		
											L [m]		
HM 26/26	0280.										0.5 m	1.0 m	1.5 m
SV	040-00001	6000	0.82	1.05	0.95	1.19	0.64	0.92	F _{z,Rd} 1.54 allow. F _z 1.10	50.0	F _{Rd} 1.53 0.77 0.40 allow. F 1.10 0.55 0.28		
HL 26/26	0281.												
SV	070-00001	6000	0.72	0.89	0.73	1.16	0.56	0.89	F _{z,Rd} 1.54 allow. F _z 1.10	40.0	F _{Rd} 1.26 0.56 0.31 allow. F 0.9 0.4 0.22		

① F_z = max. load bearing capacity of the channel lips

Accessories

HPE 26/26

Channel end cap
→ see page 58

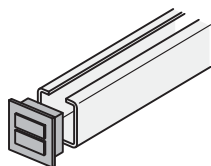

SDM - 28/6

Rubber vibration absorber
→ see catalogue MT-FFC

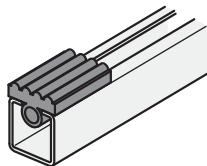

Further design properties

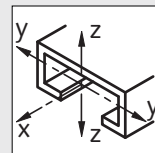

Cross section data
pages 62, 64

HALFEN FRAMING SYSTEMS

Framing Channels – Light Duty Framing Systems

Framing channel HM 28/15 and HL 28/15

HM 28/15 and HL 28/15 cold-rolled

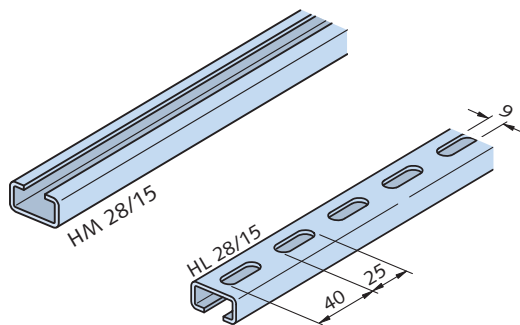
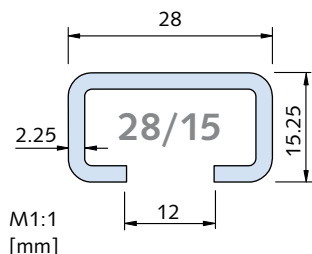

Suitable HALFEN Bolts
HS 28/15 → see page 51

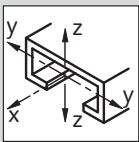
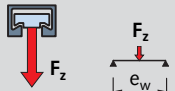
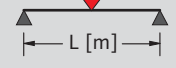
Dimensions and cross-section properties								Load capacities					
Material	Order no.	Length [mm]	Weight G [kg/m]	Cross section area A [cm ²]	Moment of inertia 		Elastic section modulus Wy, Wz [cm ³]		Max. point-load bearing capacity 		Bending load capacity at span L F [kN] 		
					Iy [cm ⁴]	Iz [cm ⁴]	Wy [cm ³]	Wz [cm ³]	Fz ① [kN]	≤ ew [cm]	0.5 m	1.0 m	1.5 m
HM 28/15	0280.	6070	1.09	1.39	0.41	1.45	0.46	1.03	Fz,Rd	8.2	FRd		
WB	010-00001								5.5		1.15	0.38	0.17
FV	010-00002								allow. Fz		allow. F		
A2 ②	010-00004								3.9		0.82	0.27	0.12
A4 ②	070-00003												
HL 28/15	0281.	6070	0.86	1.16	0.32	1.35	0.40	0.98	Fz,Rd	7.0	FRd		
WB	080-00001								5.5		0.98	0.31	0.14
FV	080-00004								allow. Fz		allow. F		
A2 ②	080-00002								3.9		0.7	0.22	0.10
A4	080-00003												

① Fz = max. load bearing capacity of the channel lips

② Stainless steel A2 on request; Note: high corrosion resistant stainless steel HCR for HM 28/15 on request

Accessories

HPE 28/15 Channel end cap
→ see page 58

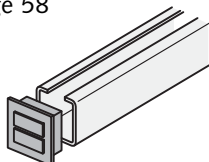

SDM 28/6 Rubber vibration absorber
→ see catalogue MT-FFC

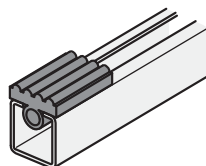

SIC 28/15 Locking washer
→ see page 56

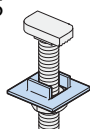

Further design properties

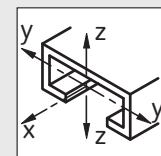

Cross section data
pages 62, 64

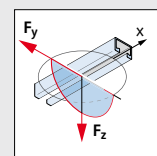

Point-load capacities
page 68

HALFEN FRAMING SYSTEMS

Framing Channels – Light Duty Framing Systems

Framing channel HM 315 (C30)

HM 315 (C30) cold-rolled

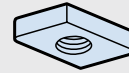
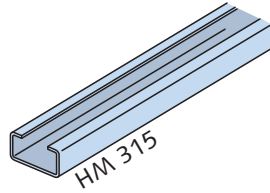
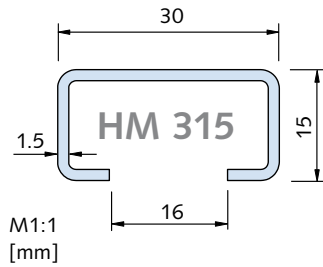

Suitable locking plates
GWP 28/15 → see page 51

Dimensions and cross-section properties									Load capacities				
Material	Order no.	Length [mm]	Weight G [kg/m]	Cross section area A [cm ²]	Moment of inertia		Elastic section modulus		Max. point-load bearing capacity		Bending load capacity at span L		
					I_y [cm ⁴]	I_z [cm ⁴]	W_y [cm ³]	W_z [cm ³]	F_z ① [kN]	$\leq e_w$ [cm]	F [kN]		
HM 315	0280.												
WB	060-00001	6000	0.77	0.97	0.30	1.26	0.32	0.84	$F_{z,Rd}$	17.7	F_{Rd}		
									2.32		0.81	0.28	0.13
FV	060-00002								allow. F_z		allow. F		
									1.66		0.58	0.20	0.09

① F_z = max. load bearing capacity of the channel lips

Accessories

SIC 28/15 Locking plate

→ see page 56

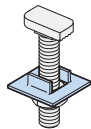

Further design properties

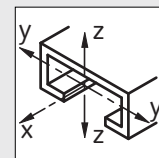

Cross section data
page 62

HALFEN FRAMING SYSTEMS

HALFEN Bolts – Light Duty Framing Systems

HALFEN Bolts HS 28/15

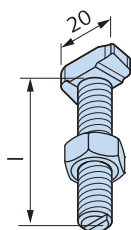

HS 28/15
HALFEN Bolts
incl. nut
Li = left-hand
thread

Not for HM 315

High corrosion resistant stainless steel
HCR on request

HS 28/15 available bolts

Length l [mm]	HS 28/15 available bolts				Length l [mm]	HS 28/15 available bolts			
	M6	M8	M10	M12		M6	M8	M10	M12
15	GVs 4.6	GVs 4.6	GVs 4.6		50		GVs 4.6	GVs 4.6	GVs 4.6
	GVs 4.6	GVs 4.6	GVs 4.6					FV 4.6	
20		GVs 8.8	A2-70		60		GVs 4.6	GVs 4.6	
		A2-70	A4-70					GVs 8.8	
25	GVs 4.6	GVs 4.6	GVs 4.6		80		GVs 4.6	GVs 4.6	GVs 4.6
		A2-70	A2-70					GVs 8.8	
30	GVs 4.6	GVs 4.6	GVs 4.6	GVs 4.6	100		GVs 4.6	GVs 4.6	
		A2-70	FV 4.6					A4-50	
35			A2-70		125			GVs 4.6	
			A4-70					A4-50	
40	GVs 4.6	GVs 4.6	GVs 4.6	GVs 4.6	150		GVs 4.6 ①	GVs 4.6	
			FV 8.8					A4-50	
			A2-70		200			GVs 4.6	
			A4-70					A4-50	

① on request

Load bearing capacities for HALFEN Bolts ①

Thread Ø	Load capacities for HALFEN Bolts					Recommended load bearing capacity per HALFEN Bolt in channel longitudinal direction		Recommended torque			
	F [kN]					F _x [kN] ②		T _{inst} [Nm]			
28/15	HS					HS		HS			
		4.6	8.8	A2-50 A4-50	A2-70 A4-70	4.6; 8.8	A2-50; A4-50; A2-70; A4-70	4.6	8.8	A2-50; A4-50	A2-70; A4-70
M6	F _{Rd}	2.9	6.4	2.5	5.4	0.14	0.14	3	-	3	-
	allow. F	2.1	4.6	1.8	3.8	0.1	0.1				
M8	F _{Rd}	5.3	11.7	4.6	9.9	0.28	0.28	8	20	8	15
	allow. F	3.8	8.3	3.3	7.1	0.2	0.2				
M10	F _{Rd}	8.3	18.6	7.3	15.6	0.42	0.42	15	40	15	30
	allow. F	5.9	13.3	5.2	11.2	0.3	0.3				
M12	F _{Rd}	12.1	27.0	10.6	22.7	0.7	0.7	25	70	25	50
	allow. F	8.6	19.3	7.6	16.2	0.5	0.5				

① Note: do not exceed the max. channel load bearing capacity

② Load capability due to friction

Locking plates

GWP 28/15

for profiles 28/15
and HM 315 (C30)

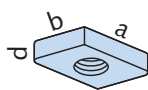

Assembly notes:

M6 and M8: insert the locking plate at an angle through the channel slot!

M10: insert the locking plate first, then fit and turn the threaded rod!

GWP 28/15 available plates

GV	A4	a [mm]	b [mm]	d [mm]
M5	-			
M6	M6	24.5	13.0	4
M8	M8			
M10	M10	33.5	17.5	5

GWP 28/15 Load capacities

Thread	F _z [kN]	
	F _{Rd}	allow. F
M5	F _{Rd}	2.1
	allow. F	1.5
M6	F _{Rd}	2.7
	allow. F	1.9
M8	F _{Rd}	3.9
	allow. F	2.8
M10	F _{Rd}	4.2
	allow. F	3.0

HALFEN FRAMING SYSTEMS

Framing Channels – Light Duty Framing Systems

Framing channel HM 20/12 and HL 20/12

HM 20/12 resp. HL 20/12 cold-rolled

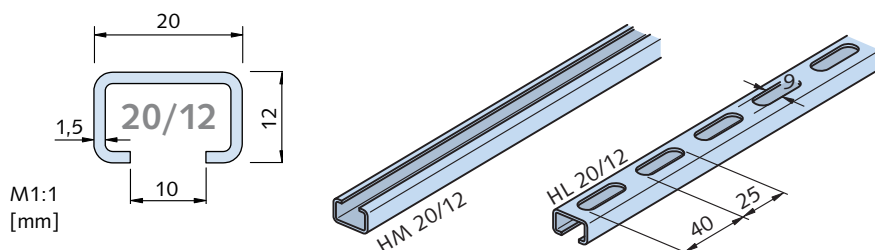

Suitable HALFEN Bolt
HS 20/12 → see page 53

Dimensions and cross-section properties									Load capacities				
Material	Order no.	Length [mm]	Weight G [kg/m]	Cross section area A [cm ²]	Moment of inertia		Elastic section modulus		Max. point-load bearing capacity		Bending load capacity at span L		
					I _y [cm ⁴]	I _z [cm ⁴]	W _y [cm ³]	W _z [cm ³]	F _z ① [kN]	≤ e _w [cm]	F [kN]		
HM 20/12	0280.	6000	0.52	0.66	0.12	0.36	0.16	0.36	F _{z,Rd} 3.14	5.8	F _{Rd}		
WB	030-00001										0.42	0.11	0.06
FV	030-00003										allow. F		
A2	030-00002										0.30	0.08	0.04
HL 20/12	0281.	6000	0.45	0.53	0.09	0.35	0.14	0.36	F _{z,Rd} 3.14	4.6	F _{Rd}		
WB	090-00001										0.32	0.08	0.04
FV	090-00002										allow. F		
A2	090-00003										0.23	0.06	0.03

① F_z = max. load bearing capacity of the channel lips

Accessories

SIC 20/12 Locking washer

→ see page 56

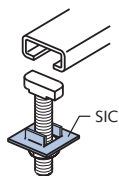

Further design properties

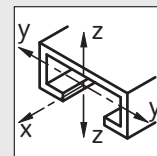

Cross section data
pages 62, 64

HALFEN FRAMING SYSTEMS

HALFEN Bolts – Light Duty Framing Systems

HALFEN Bolts HS 20/12

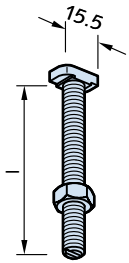

HS 20/12
HALFEN Bolts
incl. nut

HS 20/12 available bolts

Length l [mm]	M6		M8	
	M6	M8	M6	M8
15	-	GVs 4.6	40	GVs 4.6
	GVs 4.6	GVs 4.6		-
20	-	A2-70	50	GVs 4.6
	GVs 4.6	GVs 4.6		-
25	-	GVs 4.6	60	GVs 4.6
	GVs 4.6	GVs 4.6		-
30	-	A2-70	80	GVs 4.6
	GVs 4.6	GVs 4.6	100	GVs 4.6
	-	A2-70	-	GVs 4.6 ①

① on request

Load bearing capacities for HALFEN Bolts ①

Thread Ø	Load capacities for HALFEN Bolts		Recommended load capacity per HALFEN Bolt in channel longitudinal direction		Recommended torque	
	$F_{y,z}$	F_x [kN]	F_x [kN] ②	T_{inst} [Nm]		
20/12	HS		HS		HS	
	4.6		4.6		4.6	
M6	F_{Rd}	2.9	0.14	3	-	
	allow. F	2.1	0.1	-	-	
M8	F_{Rd}	5.3	0.28	8	8	
	allow. F	3.8	0.2	-	-	

① Note: do not exceed the max. channel load bearing capacity

② Load capability due to friction

Locking plates

Locking plate GWP 20/12

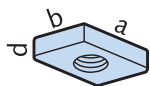

GWP 20/12 available plates

GV Thread	A4 Thread	a [mm]	b [mm]	d [mm]
M5	M5	16	9	4
M6	M6			

Load capacities for GWP 20/12

Thread	F_z [kN]	
	F_{Rd}	allow. F
M5	F_{Rd}	2.1
	allow. F	1.5
M6	F_{Rd}	2.7
	allow. F	1.9

HALFEN FRAMING SYSTEMS

Accessories

MU

Hexagonal nuts
EN ISO 4032/
DIN 934

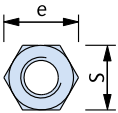

GV	A4	S/m	S/m	e
Galvanized F.k. 8 Thread	Stainless steel A4 Thread	DIN [mm]	ISO [mm]	[mm]
M6	M6	10/5	10/6	11.5
M8	M8	13/6.5	13/7.5	15.0
M10	M10	17/8	16/ 9.5	19.6
M12	M12	19/10	18/12	21.9
M16	M16	24/13	24/15.5	27.7
M20	M20	30/16	30/19	34.6
M24	-	36/19	36/22	41.5
FV	A2	S/m	S/m	e
Hot-dip galvanized Thread	Stainless steel A4 Thread	DIN [mm]	EN [mm]	[mm]
M6, M8	M8	13/6.5	13/7.5	15.0
M10	M10	17/08	16/9.5	19.6
M12	M12	19/10	18/12	21.9
M16	M16	24/13	24/15.5	27.7

US

Washers
DIN 9021/
EN ISO
7094/
DIN 440

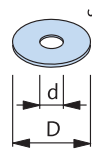

DIN	GV	A4	D	d	s
	Galvanized For bolt	Stainless steel A4 For bolt	[mm]	[mm]	[mm]
440	M6	-	22	6.6	2
9021	M8	M8	24	8.4	2
9021	M10	M10	30	10.5	2.5
440	M12	-	45	13.5	4
9021	M12	M12	37	13	3
9021	M16	M16	50	17	3
440	M20	-	72	22	6

Ordering example: **US - M12 - GV - DIN 9021**

US

Washers
EN ISO
7089/
DIN 125

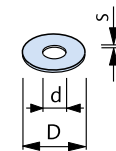

GV	A4	D	d	s
Galvanized For bolt	Stainless steel A4 For bolt	[mm]	[mm]	[mm]
M6	M6	12	6.4	1.6
M8	M8	16	8.4	1.6
M10	M10	21	10.5	2
M12	M12	24	13	2.5
M16	M16	30	17	3
M20	M20	37	21	3
M24	-	44	25	4
FV	A2	D	d	s
Hot-dip galva- nized For bolt	Stainless steel A2 For bolt	[mm]	[mm]	[mm]
-	M8	17	8.4	1.6
M10	M10	21	10.5	2
M12	M12	24	13	2.5
M16	M16	30	17	3

Ordering example: **US - M12 - GV - DIN 125**

VUS

Square washers

FV	A4	a x b x d
Hot-dip galvanized For bolt size:	Stainless steel A4 For bolt size:	[mm]
M10	M10	40 x 40 x 5
M12	M12	40 x 40 x 5
M16	M16	40 x 40 x 5
M10	M10	37 x 37 x 5
M12	M12	37 x 37 x 5
M16	M16	37 x 37 x 5
M20	M20	37 x 37 x 5

VUS 40/25
for profile
40/25;
HZA
41/22

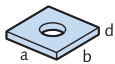

VUS 49/30
for profile
54/33,
49/30

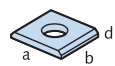

VUS 52/34
for profile
52/34,
50/30

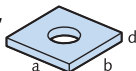

VUS 72/49
for profile
72/48,
72/49

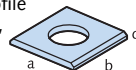

VUS 41/41
for all
41/..
profiles

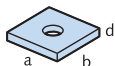

Ordering example: **VUS 52/34 - FV - M20**

SIC

Locking
washer

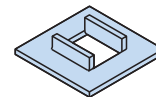

GV	A4	Suitable for HALFEN Bolts	
Galvanized	Stainless steel	Type	Dimensions
SIC - 50/30 - GV	SIC - 50/30 - A4	50/30	M16, M20
SIC - 40/22 - GV	SIC - 40/22 - A4	38/17 40/22	M16
SIC - 38/23 - GV	-	38/23	M16
SIC - 29/20 - GV	-	29/20	M12
SIC - 38/17 - GV	SIC - 38/17 - A4	38/17 40/22	M12, M10
SIC - 28/15 - GV	SIC - 28/15 - A4	28/15	M8, M10
SIC - 20/12 - GV	SIC - 20/12 - A4	20/12	M8

Ordering example: **SIC - 38/17 - GV**

Application VUS:

for shimming non-flush
installation of HALFEN
Anchor channels or for
stand-off installations
→ see page 69

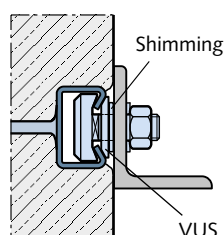

Application SIC:

for securing HALFEN Bolts;
prevents bolts turning when
tightening nuts

Assembly scheme:

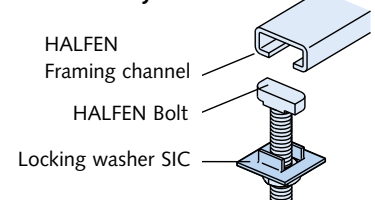

HALFEN FRAMING SYSTEMS

Accessories

GWS

Threaded rods
DIN 976-1



GV	A4	Length	F _{Rd}	allow. F
Galvanized F.k. 4.6 Thread	Stainless steel A4 Thread	[mm]	Ⓛ [kN]	[kN]
M6	M6	1000	3.1	2.2
M8	M8	1000	5.6	4.0
M10	M10	1000	9.0	6.4
M12	M12	1000	13.0	9.3
M16	M16	1000	24.2	17.3
M20	M20	1000	37.8	27.0
M24	-	1000	54.3	38.8

Ordering example: **GWS - M12 × 1000 - GV**

VBM

Coupler sleeves,
round

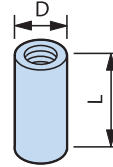

GV	A4	D	L	F _{Rd}	allow. F
Galvanized Thread	Stainless steel Thread	[mm]	[mm]	Ⓛ [kN]	[kN]
M6	M6	10/10	15	3.1	2.2
M8	M8	12/14	20	5.6	4.0
M10	M10	13/16	25	9.0	6.4
M12	M12	16/20	30	13.0	9.3
M16	M16	21/25	40	24.2	17.3
M20	M20	26/32	50	37.8	27.0

Ordering example: **VBM - A4 - M16**

HSK

Hexagonal head
bolts
EN ISO 4017/
DIN 933
(without nut)

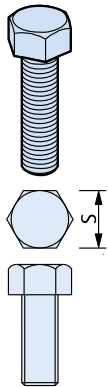

Hex bolts are used
in combination with
HALFEN Locking
plates

GV 8.8	A4	S	S
Galvanized FK 8.8 Dimensions	Stainless steel Dimensions	DIN [mm]	EN ISO [mm]
M 6 × 12		10	10
M 6 × 25			
M 8 × 25	M 8 × 25	13	13
M 8 × 40			
M 10 × 20			
M 10 × 30	M 10 × 30		
M 10 × 45	M 10 × 45	17	16
M 10 × 60			
M 10 × 70			
M 12 × 22			
M 12 × 25	M 12 × 25		
M 12 × 30	M 12 × 30		
M 12 × 40	M 12 × 40	19	18
M 12 × 50			
M 12 × 60	M 12 × 60		
M 12 × 80	M 12 × 80		
M 12 × 90			
M 16 × 40	M 16 × 40		
M 16 × 60	M 16 × 60	24	24
M 16 × 90	M 16 × 90		

SKM

Hexagonal coup-
ler sleeves with
view holes

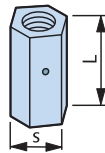

FV	A4	S	L	F _{Rd}	allow. F
Hot-dip galvanized Thread	Stainless steel Thread	[mm]	[mm]	Ⓛ [kN]	[kN]
M10	M10	13	40	9.0	6.4
M12	M12	17	40	13.0	9.3
M16	M16	22	50	24.2	17.3

Ordering example: **SKM - FV - M12**

SPH

Turnbuckles
with right-
and left-hand
thread

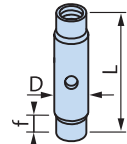

f = min. screw
depth
M12 ≅ 10mm
M16 ≅ 13 mm

A4	A4	D	D
Stainless steel Thread M12 × Length L [mm]	Stainless steel Thread M16 × Length L [mm]	For M12 [mm]	For M16 [mm]
M12 × 60	M16 × 60	16	22
M12 × 75	M16 × 75	16	22
M12 × 95	M16 × 95	16	22
M12 × 115	M16 × 115	16	22
M12 × 135	M16 × 135	16	22
allow. F = 5 kN F _{Rd} = 7 kN	allow. F = 10 kN F _{Rd} = 14 kN		

Ordering example: **SPH - A4 - M12 × 75**

HJV

Adjustment
coupler

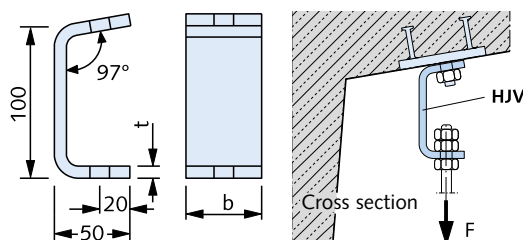
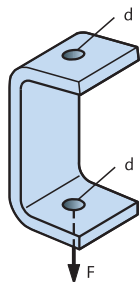

FV	A4	t	b	d	max. F _{Ed} Ⓛ	allow. F
Hot-dip galvanized Type	Stainless steel Type	[mm]	[mm]	[mm]	[kN]	[kN]
1	1	6	40	13	2.1	1.5
2	2	8	50	17	4.6	3.3
3	3	10	50	17	7.0	5

RM

Ring nut
DIN 582
from 2003-8



GV	d	F _{Rd}	allow. F
C 15E, galvanized Thread	[mm]	Ⓛ [kN]	[kN]
M8	20	2.0	1.4
M10	25	3.2	2.3
M12	30	4.8	3.4
M16	35	9.8	7.0
M20	40	16.8	12.0

Ordering example: **RM - GV - M12**

① Recommended design value of the load capacity
with a centric tensile stress

② Recommended design value of the load

HALFEN FRAMING SYSTEMS

Accessories

HPE Channel end caps

Channel end caps in plastic



Type **HPE 63/63**
Colour: blue

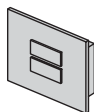

Type **HPE**
Colour: black

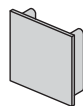

Type **HPE 41/41**
Type **HPE 41/22**
Colour: black

Product range		
Description	Order no. 0318.000-	Suitable for channel
HPE 63/63	00010	63/63
HPE 52/34	00001	52/34
HPE 50/40	00002	50/40
HPE 41/41	00003	41/41
HPE 41/22	00004	41/22
HPE 36/36	00005	36/36
HPE 28/28	00006	28/28
HPE 28/15	00011	28/15
HPE 26/26	00007	26/26

Assembly diagram:

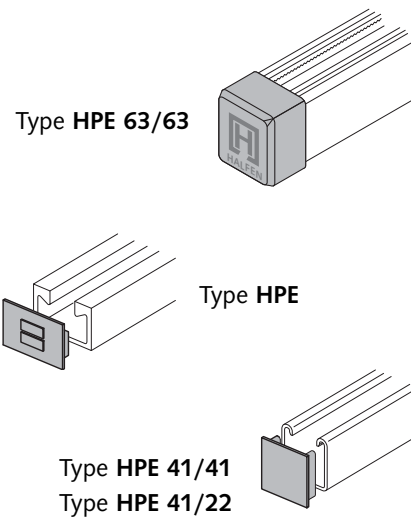

PA Channel cover

The channel cover **PA** is used to protect the channel slot against dirt etc.

Type overview			
Type	PA 41	PA 22	PA 18 H
	Suitable for profiles: 50/40, 50/30, 486, all 41/... Profiles	Suitable for profile 52/34	Suitable for profiles 36/36, 38/17
Quality: hard PVC (KS)	 white	 medium grey	 medium grey
Quality: steel sendzimir zinc plated (SV)			

Assembly diagram:

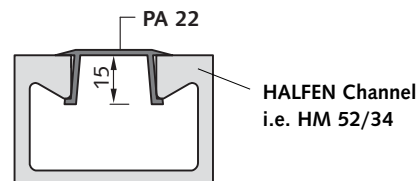

Available types				
Type	Length [mm]	Order no. 0321.000-		
PA - 41 - KS	- 3000	00002		
PA - 41 - SV	- 3000	00001		
PA - 22 - KS	- 3000	00003		
PA - 18H - KS	- 3000	00004		

HALFEN FRAMING SYSTEMS

HALFEN Cantilevers

Cantilevers KON

Flexible comprehensive support system

Whether for low or very high requirements: you are guaranteed to find the most cost-efficient solution for your requirements using the HALFEN product range. With its adjustable bolt connections, components can be installed, dismantled, moved and adjusted quickly and simply.

Short assembly times

The flexibility of HALFEN Cantilevers/ Bolts make them ideal when the positions and sizes of bolts can not be defined during the planning stage of a project. Using the HALFEN product range avoids costly and complex adjustment, drilling or thread cutting in corrosion protected components.



Pipe supports with cantilevers brackets in a sewage treatment plant

Cantilever 52:

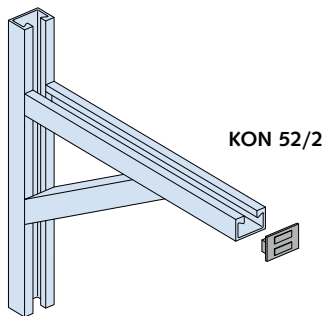

Note: Depending on the number of items ordered, custom cantilevers are available

Cantilever 41:

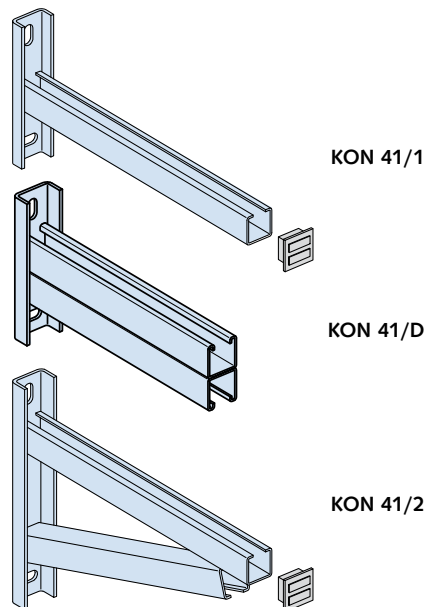

Cantilever 36/28:

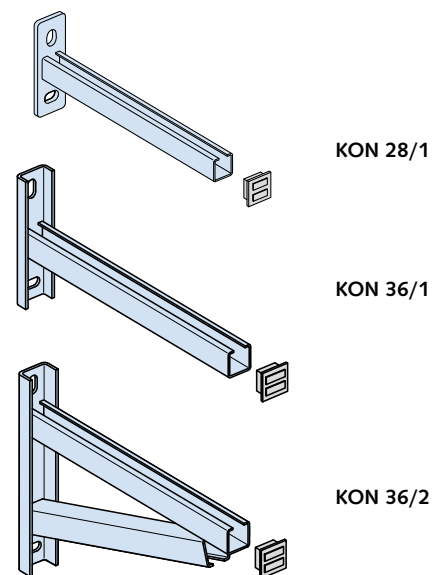

Further information on HALFEN Cantilevers is available at www.halfen.de
Take a look at our catalogue "Flexible Framing Connections":
"HALFEN Flexible Framing Connections" Technical Product Information, MT-FFC.



HALFEN FRAMING SYSTEMS

HALFEN Framing Channels, Hot-Rolled, Non-Slotted – Bending Load Capacities

Framing Channels	Materials/coatings	Channel weight	Cross section area	Centroid	Moment of inertia		Elastic/plastic section modulus				Max. point-load bearing capacity ①			
					I_y [cm ⁴]	I_z [cm ⁴]	$W_{y,el}$ [cm ³]	$W_{z,el}$ [cm ³]	$W_{y,pl}$ [cm ³]	$W_{z,pl}$ [cm ³]	allow. F_z [kN]	$F_{z,Rd}$ [kN]	e_w [cm]	
														G [kg/m]
	WB - FV - A4	HM 72/48	8.85	11.27	2.45	34.97	83.35	14.28	23.15	18.28	28.94	47.0	65.8	30.0
		HM 55/42	6.76	8.61	1.99	18.75	36.29	8.49	13.32	11.73	16.69	38.6	54.0	25.0
		HM 52/34	4.98	6.35	1.61	9.33	23.74	5.36	9.04	7.19	11.50	25.9	36.3	20.0
		HM 50/30	3.26	4.15	1.37	5.26	13.78	3.23	5.62	4.38	7.05	14.4	20.2	20.0
		HM 40/22	2.12	2.70	1.05	1.99	5.77	1.59	2.92	2.17	3.68	8.2	11.4	15.0
	⑤ - ⑤ - ⑤	HM 72/48 D ④	17.70	22.54	4.85	205.15	166.70	42.30	46.30	55.20	57.89	47.0	65.8	30.0
		HM 55/42 D ④	13.52	17.22	4.20	105.70	72.58	25.17	26.64	34.27	33.37	38.6	54.0	25.0
		HM 52/34 D ④	9.96	12.70	3.35	51.49	47.48	15.37	18.09	20.42	23.00	25.9	36.3	20.0
		HM 50/30 D ④	6.52	8.27	3.00	26.56	28.14	8.85	11.49	11.52	14.27	14.4	20.2	20.0
		HM 40/22 D ④	4.24	5.33	2.30	10.06	11.61	4.38	5.88	5.73	7.36	8.2	11.4	15.0
	WB - FV - A4	HZM 64/44	7.15	9.10	2.10	23.83	53.94	10.36	16.85	13.66	20.86	38.1	53.3	25.0
		HZM 53/34	4.63	5.88	1.54	9.19	23.18	4.95	8.83	6.80	10.94	30.9	43.3	20.0
		HZM 41/27	3.38	4.31	1.19	3.90	9.49	2.57	4.75	3.74	5.98	17.8	25.0	20.0
		HZM 38/23	2.43	3.10	0.97	2.11	6.17	1.59	3.25	2.31	4.06	12.8	18.0	20.0
		HZM 29/20	1.55	1.99	0.88	1.02	2.42	0.91	1.67	1.31	2.06	7.8	10.9	15.0
	⑤ - ⑤ - ⑤	HZM 64/44 D ④	14.3	18.21	4.40	127.94	107.87	29.08	33.71	38.23	41.72	38.1	53.3	25.0
		HZM 53/34 D ④	9.26	11.75	3.40	46.38	46.36	13.64	17.66	18.14	21.89	30.9	43.3	20.0
		HZM 41/27 D ④	6.76	8.62	2.70	19.91	18.98	7.37	9.49	10.22	11.96	17.8	25.0	20.0
		HZM 38/23 D ④	4.86	6.19	2.30	10.04	12.35	4.36	6.50	6.00	8.13	12.8	18.0	20.0
		HZM 29/20 D ④	3.10	3.97	2.00	5.12	4.84	2.56	3.34	3.49	4.11	7.8	10.9	15.0

① Observe the minimum distance a_e between the channel end and the load point (HALFEN Bolt, locking plate):
heavy and medium duty framing systems: $a_e \geq 30$ mm,
light duty framing systems: $a_e \geq 20$ mm.

② Do not exceed the bolt load capacity or the max. channel load bearing capacity.

③ For maximum point-load capacity:
 $F_z = \text{max. load bearing capacity of the channel lips.}$

④ Take constructive measures to prevent failure caused by bulging, tilting and buckling.

⑤ On request.

HALFEN FRAMING SYSTEMS

HALFEN Framing Channels, Hot-Rolled, Non-Slotted – Bending Load Capacities

Material: steel, type WB, FV E= 210.000 N/mm²

Bending load capacity at span L (single span element) ②

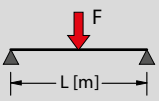
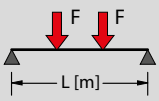
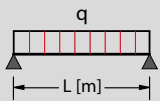
F [kN]		F [kN]		q [kN/m]	
allow. F _z	F _{Rd}	allow. F _z	F _{Rd}	allow. F _z	F _{Rd}
0.50 m		1.00 m		1.50 m	
22.3	31.2	11.2	15.6	7.4	10.4
16.8	23.5	8.4	11.7	5.6	7.8
8.8	12.3	4.4	6.1	2.8	3.9
5.4	7.5	2.7	3.7	1.6	2.2
2.6	3.7	1.3	1.9	0.6	0.8
0.50 m		1.00 m		1.50 m	
16.7	23.4	8.4	11.7	5.6	7.8
12.6	17.6	6.3	8.8	3.3	4.6
6.6	9.2	3.3	4.6	1.6	2.3
4.0	5.6	2.0	2.8	0.9	1.3
2.0	2.8	0.8	1.1	0.3	0.5
0.50 m		1.00 m		1.50 m	
89.3	125.0	22.3	31.2	9.9	13.9
67.0	93.8	16.8	23.5	6.0	8.4
35.1	49.1	8.8	12.3	3.0	4.2
21.4	30.0	5.4	7.5	1.7	2.3
10.6	14.8	2.1	3.0	0.6	0.9

allow. F _z	F _{Rd}	allow. F _z	F _{Rd}	allow. F _z	F _{Rd}
1.00 m		2.00 m		3.00 m	
33.7	47.2	16.8	23.6	11.2	15.7
24.5	34.3	12.2	17.1	7.9	11.0
12.5	17.4	6.2	8.7	3.8	5.4
7.0	9.8	3.5	4.9	2.0	2.8
3.5	4.9	1.7	2.4	0.8	1.1
1.00 m		2.00 m		3.00 m	
25.3	35.4	12.6	17.7	8.4	11.8
18.4	25.7	9.2	12.8	4.6	6.5
9.3	13.1	4.7	6.5	2.3	3.2
5.3	7.4	2.6	3.7	1.2	1.6
2.6	3.7	1.0	1.4	0.4	0.6
1.00 m		2.00 m		3.00 m	
67.4	94.3	16.8	23.6	7.5	10.5
49.0	68.5	12.2	17.1	4.2	5.9
24.9	34.9	6.2	8.7	2.1	2.9
14.1	19.7	3.5	4.9	1.1	1.5
7.0	9.8	1.4	1.9	0.4	0.6

allow. F _z	F _{Rd}	allow. F _z	F _{Rd}	allow. F _z	F _{Rd}
0.50 m		1.00 m		1.50 m	
24.8	34.8	12.4	17.4	7.1	10.0
12.4	17.3	6.2	8.6	2.7	3.8
6.8	9.5	2.6	3.7	1.2	1.6
4.2	5.9	1.4	2.0	0.6	0.9
2.4	3.3	0.7	1.0	0.3	0.4
0.50 m		1.00 m		1.50 m	
18.6	26.1	9.3	13.0	4.2	5.8
9.3	13.0	3.6	5.1	1.6	2.3
5.1	7.1	1.5	2.2	0.7	1.0
3.2	4.4	0.8	1.2	0.4	0.5
1.6	2.3	0.4	0.6	0.2	0.3
0.50 m		1.00 m		1.50 m	
99.4	139.1	24.8	34.8	7.6	10.6
49.4	69.2	9.9	13.8	2.9	4.1
27.2	38.1	4.2	5.9	1.2	1.7
16.8	23.5	2.3	3.2	0.7	0.9
8.8	12.3	1.1	1.5	0.3	0.5

allow. F _z	F _{Rd}	allow. F _z	F _{Rd}	allow. F _z	F _{Rd}
1.00 m		2.00 m		3.00 m	
34.8	48.7	17.4	24.3	9.6	13.4
16.5	23.1	7.8	10.9	3.5	4.8
9.3	13.0	3.3	4.7	1.5	2.1
5.5	7.6	1.7	2.4	0.7	1.0
3.2	4.4	0.9	1.2	0.4	0.5
1.00 m		2.00 m		3.00 m	
26.1	36.5	12.6	17.7	5.6	7.8
12.4	17.3	4.6	6.4	2.0	2.8
7.0	9.8	2.0	2.7	0.9	1.2
4.0	5.5	1.0	1.4	0.4	0.6
2.0	2.8	0.5	0.7	0.2	0.3
1.00 m		2.00 m		3.00 m	
69.5	97.3	17.2	24.1	5.1	7.1
33.0	46.2	6.2	8.7	1.8	2.6
18.6	26.0	2.7	3.7	0.8	1.1
10.8	15.1	1.3	1.9	0.4	0.6
5.5	7.7	0.7	1.0	0.2	0.3

All load capacities are calculated using the elastic-plastic method acc. to EN 1993-1, partial safety factor $\gamma_F = 1,4$; deflection $\leq l / 150$.
 Determination of the allowable value
allow. F_z = F_{Rd} / 1.4

Note: For stainless steel framing channels the bending deflection value must be verified separately using the valid E-modulus of elasticity.

HALFEN FRAMING SYSTEMS

HALFEN Framing Channels, Cold-Rolled, Non-Slotted – Bending Load Capacities

Framing Channels	Materials/coatings	Channel weight	Cross section area	Centroid	Moment of inertia		Elastic/plastic section modulus				Max. point-load bearing capacity ①					
					G [kg/m]	A [cm ²]	e ₂ [cm]	I _y [cm ⁴]	I _z [cm ⁴]	W _{y,el} [cm ³]	W _{z,el} [cm ³]	W _{y,pl} [cm ³]	W _{z,pl} [cm ³]	Max. point-load bearing capacity ①		
														allow. F _z [kN]	F _{z,Rd} [kN]	e _w [cm]
	WB - FV - A4	HM 49/30	2.88	3.67	1.23	4.16	13.23	2.35	5.29	3.56	6.49	4.9	6.9	46.0		
		HM 40/25	2.09	2.66	1.02	2.05	6.09	1.39	3.05	2.11	3.75	3.8	5.3	33.0		
		HM 50/40	3.35	4.26	1.72	8.64	15.49	3.96	6.32	5.53	7.62	5.4	7.6	63.0		
		HM 486	2.31	2.95	1.15	2.97	9.62	1.92	4.01	2.71	4.95	3.5	4.7	47.0		
		HM 422 (C40)	1.55	1.98	0.93	1.27	4.29	1.04	2.17	1.46	2.71	2.5	3.5	36.0		
	WB SV FV - A4	HM 41/41	2.67	3.40	1.82	7.47	9.44	3.24	4.57	4.57	5.37	5.6	7.8	49.0		
		HZM 41/41	2.63	3.36	1.80	7.34	9.37	3.15	4.54	4.48	5.31	5.6	7.8	47.0		
		HM 41/22	1.86	2.38	0.85	1.28	5.56	1.05	2.69	1.59	3.37	5.6	7.8	15.0		
		HZM 41/22	1.83	2.33	0.84	1.26	5.48	1.03	2.66	1.56	3.32	5.6	7.8	14.0		
	WB SV FV - -	HM 41/83 ④	4.29	5.47	3.84	43.82	17.22	9.91	8.34	13.73	9.38	5.6	7.8	148.0		
		HM 41/62 ④	3.48	4.44	2.83	20.96	13.34	6.21	6.46	8.63	7.38	5.6	7.8	92.0		
	WB - FV - A4	HM 41/41 D ④	5.34	6.81	4.13	37.60	18.88	9.10	9.14	12.42	10.75	5.6	7.8	49.0		
		HZM 41/41 D ④	5.27	6.71	4.13	36.45	18.73	8.83	9.07	12.09	10.63	5.6	7.8	47.0		
		HM 41/22 D ④	3.73	4.75	2.07	6.02	11.11	2.91	5.38	4.06	6.75	5.6	7.8	15.0		
		HZM 41/22 D ④	⑤	3.58	4.65	2.07	5.83	10.97	2.82	5.31	3.92	6.63	5.6	7.8	14.0	
		HM 41/62 D ④	WB - ⑤ - A4	6.97	8.88	6.20	112.88	26.68	18.21	12.92	25.10	14.76	5.6	7.8	92.0	
	WB - FV - A4	HM 36/36	2.20	2.80	1.53	4.54	5.89	2.19	3.27	3.19	3.85	4.4	6.2	44.0		
		HM 38/17	1.78	2.27	0.70	0.84	4.13	0.80	2.20	1.21	2.82	4.8	6.7	11.0		
		HM 315 (C30)	0.77	0.98	0.58	0.30	1.26	0.32	0.84	0.47	1.03	1.66	2.32	17.7		
		HM 28/28	1.36	1.73	1.22	1.70	2.01	1.08	1.49	1.54	1.77	3.0	4.20	31.0		
		HM 26/26	0.82	1.05	1.12	0.95	1.19	0.64	0.92	0.90	1.06	1.10	1.54	50.0		
		HM 28/15	1.09	1.39	0.64	0.41	1.45	0.46	1.03	0.67	1.31	3.90	5.50	8.2		
		HM 20/12	0.52	0.66	0.48	0.12	0.36	0.16	0.36	0.25	0.45	2.24	3.14	5.8		

① Observe the minimum distance a_e between the channel end and the load point (HALFEN Bolt, locking plate):
heavy and medium duty framing systems: $a_e \geq 30$ mm,
light duty framing systems: $a_e \geq 20$ mm.

② Do not exceed the bolt load capacity or the max. channel load bearing capacity.

③ For maximum point-load capacity:
 $F_z = \text{max. load bearing capacity of the channel lips.}$

④ Take constructive measures to prevent failure caused by bulging, tilting and buckling.

⑤ On request.

HALFEN FRAMING SYSTEMS

HALFEN Framing Channels, Cold-Rolled, Non-Slotted – Bending Load Capacities

Material: steel, type WB, FV, SV E= 210.000 N/mm²

Bending load capacity at span L (single span element) ②

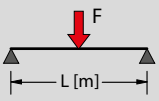
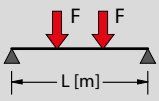
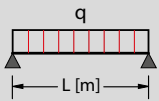
F [kN]		F [kN]		q [kN/m]	
allow. F _z	F _{Rd}	allow. F _z	F _{Rd}	allow. F _z	F _{Rd}
0.50 m	1.00 m	1.50 m	0.50 m	1.00 m	1.50 m
4.3	6.1	2.2	3.0	1.2	1.7
2.6	3.6	1.3	1.8	0.6	0.9
6.8	9.5	3.4	4.7	2.3	3.2
3.3	4.6	1.7	2.3	0.9	1.2
1.8	2.5	0.9	1.2	0.4	0.5

F [kN]		F [kN]		q [kN/m]	
allow. F _z	F _{Rd}	allow. F _z	F _{Rd}	allow. F _z	F _{Rd}
0.50 m	1.00 m	1.50 m	0.50 m	1.00 m	1.50 m
3.3	4.6	1.6	2.3	0.7	1.0
1.9	2.7	0.8	1.1	0.4	0.5
5.1	7.1	2.5	3.5	1.5	2.1
2.5	3.5	1.2	1.6	0.5	0.7
1.3	1.9	0.5	0.7	0.2	0.3

q [kN/m]		q [kN/m]		q [kN/m]	
allow. q _z	q _{Rd}	allow. q _z	q _{Rd}	allow. q _z	q _{Rd}
0.50 m	1.00 m	1.50 m	0.50 m	1.00 m	1.50 m
17.4	24.3	4.3	6.1	1.3	1.9
10.3	14.5	2.2	3.1	0.7	0.9
27.0	37.8	6.8	9.5	2.8	3.9
13.2	18.5	3.2	4.5	0.9	1.3
7.1	10.0	1.4	1.9	0.4	0.6

F [kN]		F [kN]		q [kN/m]	
allow. F _z	F _{Rd}	allow. F _z	F _{Rd}	allow. F _z	F _{Rd}
0.50 m	1.00 m	1.50 m	0.50 m	1.00 m	1.50 m
5.6	7.8	2.8	3.9	1.9	2.6
5.5	7.7	2.7	3.8	1.8	2.6
1.9	2.7	0.9	1.2	0.4	0.5
1.9	2.7	0.8	1.2	0.4	0.5

q [kN/m]		q [kN/m]		q [kN/m]	
allow. q _z	q _{Rd}	allow. q _z	q _{Rd}	allow. q _z	q _{Rd}
0.50 m	1.00 m	1.50 m	0.50 m	1.00 m	1.50 m
22.3	31.2	5.6	7.8	2.4	3.3
21.9	30.6	5.5	7.7	2.3	3.3
7.8	10.9	1.4	1.9	0.4	0.6
7.6	10.6	1.4	1.9	0.4	0.6

F [kN]		F [kN]		q [kN/m]	
allow. F _z	F _{Rd}	allow. F _z	F _{Rd}	allow. F _z	F _{Rd}
1.00 m	2.00 m	3.00 m	1.00 m	2.00 m	3.00 m
8.4	11.7	4.2	5.9	2.8	3.9
5.3	7.4	2.6	3.7	1.6	2.2
6.3	8.8	3.1	4.4	1.9	2.7
2.0	2.8	0.9	1.3	0.9	1.3

q [kN/m]		q [kN/m]		q [kN/m]	
allow. q _z	q _{Rd}	allow. q _z	q _{Rd}	allow. q _z	q _{Rd}
1.00 m	2.00 m	3.00 m	1.00 m	2.00 m	3.00 m
16.8	23.5	4.2	5.9	1.7	2.4
10.5	14.7	2.6	3.7	0.8	1.2

F [kN]		F [kN]		q [kN/m]	
allow. F _z	F _{Rd}	allow. F _z	F _{Rd}	allow. F _z	F _{Rd}
1.00 m	1.50 m	2.00 m	1.00 m	1.50 m	2.00 m
7.6	10.6	5.1	7.1	3.8	5.3
7.4	10.3	4.9	6.9	3.7	5.2
2.5	3.5	1.7	2.3	1.0	1.4
2.4	3.4	1.6	2.2	1.0	1.4
15.3	21.4	10.2	14.3	7.7	10.7

q [kN/m]		q [kN/m]		q [kN/m]	
allow. q _z	q _{Rd}	allow. q _z	q _{Rd}	allow. q _z	q _{Rd}
1.00 m	1.50 m	2.00 m	1.00 m	1.50 m	2.00 m
15.2	21.2	6.7	9.4	3.8	5.3
14.8	20.7	6.6	9.2	3.7	5.2
5.0	6.9	1.9	2.7	0.8	1.1
4.8	6.7	1.9	2.6	0.8	1.1
30.6	42.9	13.6	19.1	7.7	10.7

F [kN]		F [kN]		q [kN/m]	
allow. F _z	F _{Rd}	allow. F _z	F _{Rd}	allow. F _z	F _{Rd}
0.50 m	1.00 m	1.50 m	0.50 m	1.00 m	1.50 m
3.9	5.5	1.9	2.7	1.3	1.8
1.5	2.1	0.6	0.8	0.3	0.4
0.6	0.8	0.2	0.3	0.1	0.1
1.9	2.6	0.9	1.3	0.5	0.7
1.1	1.5	0.5	0.8	0.3	0.4
0.8	1.2	0.3	0.4	0.12	0.17
0.3	0.42	0.08	0.11	0.03	0.05

q [kN/m]		q [kN/m]		q [kN/m]	
allow. q _z	q _{Rd}	allow. q _z	q _{Rd}	allow. q _z	q _{Rd}
0.50 m	1.00 m	1.50 m	0.50 m	1.00 m	1.50 m
15.6	21.8	3.9	5.5	1.4	2.0
5.9	8.3	0.9	1.3	0.3	0.4
2.3	3.2	0.3	0.4	0.1	0.1
7.5	10.5	1.8	2.6	0.5	0.8
4.4	6.1	1.0	1.4	0.3	0.4
3.3	4.6	0.4	0.6	0.13	0.2
1.0	1.40	0.12	0.17	0.04	0.05





All load capacities were calculated using the elastic-plastic method acc. to EN 1993-1, partial safety factor $\gamma_F = 1,4$; deflection $\leq l / 150$.

Determination of the allowable value
allow. F_z = F_{Rd} / 1.4

Note: For stainless steel framing channels the bending deflection value must be verified separately using the valid E-modulus of elasticity.

HALFEN FRAMING SYSTEMS

HALFEN Framing Channels, Cold-Rolled, Slotted – Bending Load Capacities

Framing Channels	Materials/coatings	Channel weight	Cross section area	Centroid	Moment of inertia		Elastic/plastic section modulus			Max. point-load bearing capacity ①					
					G [kg/m]	A [cm²]	e ₂ [cm]	I _y [cm ⁴]	I _z [cm ⁴]	W _{y,el} [cm³]	W _{z,el} [cm³]	W _{y,pl} [cm³]	zul. F _z [kN]	F _{z,Rd} [kN]	e _w [cm]
	HL 50/40	WB - FV - A4	3.15	3.73	1.95	7.14	15.36	3.65	6.27	4.68	5.4	7.6	53.0		
	HXL 63/63	- - FV - -	6.35	7.09	3.29	33.07	42.95	10.06	13.63	13.51	5.6	7.8	134.0		
	HL 41/41	WB SV FV - A4	2.46	2.98	1.99	6.07	9.16	2.84	4.43	3.82	5.6	7.8	42.0		
	HL 41/22	WB SV FV - A4	1.57	1.95	0.96	0.99	5.27	0.89	2.55	1.27	5.6	7.8	12.0		
	HXL 41/41	WB - FV - A4	2.46	2.90	1.95	5.87	9.04	2.69	4.38	3.70	5.6	7.8	41.0		
	HXL 41/22	WB - FV - A4	1.57	1.87	0.94	0.97	5.15	0.86	2.49	1.23	5.6	7.8	12.0		
	HL 41/83 ④	WB ⑤ FV - -	3.93	5.02	4.07	37.07	16.93	8.85	8.20	12.03	5.6	7.8	133.0		
	HL 41/62 ④	WB ⑤ FV - -	3.14	3.99	3.04	17.27	13.03	5.47	6.31	7.35	5.6	7.8	81.0		
	HL 36/36	WB - FV - A4	2.00	2.42	1.75	3.65	5.78	1.97	3.21	2.64	4.4	6.2	36.0		
	HL 28/28	WB SV FV - A4	1.22	1.48	1.41	1.33	1.98	0.95	1.47	1.25	3.0	4.2	25.5		
	HL 28/15	WB - FV A2 A4	0.86	1.16	0.71	0.32	1.35	0.40	0.98	0.55	3.9	5.5	7.0		
	HL 26/26	- SV - - -	0.72	0.89	1.31	0.73	1.16	0.56	0.89	0.72	1.1	1.5	40.0		
	HL 20/12	WB - FV A2 -	0.45	0.53	0.59	0.09	0.35	0.14	0.36	0.19	2.2	3.1	4.6		

HL/HXL channel dimensions/holes and spacings				
Profile HL/HXL	D [mm]	L [mm]	A [mm]	a [mm]
50/40	18	40	60	20
63/63	14	28	250	222
41/41	14	28	50	22
41/22	14	28	50	22
41/83	14	28	50	22
41/62	14	28	50	22
36/36	15	40	60	20
28/28	12.5	25	40	15
26/26	12.5	25	40	15
28/15	9	25	40	15
20/12	9	25	40	15

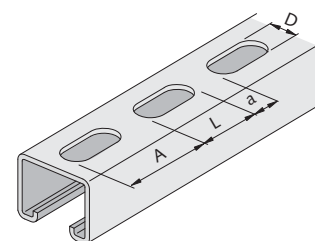

Other hole sizes and spacings on request

HALFEN FRAMING SYSTEMS

HALFEN Framing Channels, Cold-Rolled, Slotted – Bending Load Capacities

Material: steel, type WB, FV, SV E= 210.000 N/mm²

Bending load capacity at span L (single span element) ②

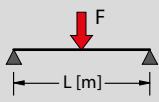

F [kN]

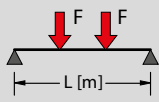

F [kN]

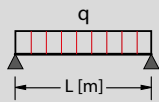

q [kN/m]

allow. F _z		F _{Rd}		allow. F _z		F _{Rd}		allow. F _z		F _{Rd}		allow. F _z		F _{Rd}		allow. q _z		q _{Rd}		allow. q _z		q _{Rd}		allow. q _z		q _{Rd}			
0.50 m		0.50 m		1.00 m		1.00 m		1.50 m		1.50 m		0.50 m		0.50 m		1.00 m		1.00 m		1.50 m		0.50 m		0.50 m		1.00 m		1.50 m	
5.7	7.98	2.9	4.06	1.9	2.66	4.3	6.02	2.1	2.94	1.3	1.82	22.9	32.06	5.7	7.98	2.3	3.22												

allow. F _z		F _{Rd}		allow. F _z		F _{Rd}		allow. F _z		F _{Rd}		allow. F _z		F _{Rd}		allow. q _z		q _{Rd}		allow. q _z		q _{Rd}		allow. q _z		q _{Rd}			
0.50 m		0.50 m		1.00 m		1.00 m		1.50 m		1.50 m		0.50 m		0.50 m		1.00 m		1.00 m		1.50 m		0.50 m		0.50 m		1.00 m		1.50 m	
16.5	23.1	8.2	11.5	5.5	7.7	12.4	17.4	6.2	8.7	4.1	5.7	66	92.4	16.5	23.1	7.3	10.2												
4.7	6.6	2.3	3.2	1.6	2.2	3.5	4.9	1.7	2.4	1.1	1.5	18.7	26.2	4.7	6.6	1.9	2.7												
1.6	2.2	0.7	1.0	0.3	0.4	1.2	1.7	0.4	0.6	0.17	0.2	6.2	8.7	1.1	1.5	0.3	0.4												
4.5	6.3	2.3	3.2	1.5	2.1	3.4	4.8	1.7	2.4	1	1.4	18.1	25.3	4.5	6.3	1.9	2.7												
1.5	2.1	0.6	0.8	0.3	0.4	1.1	1.5	0.4	0.6	0.16	0.2	6	8.4	1	1.4	0.3	0.4												

allow. F _z		F _{Rd}		allow. F _z		F _{Rd}		allow. F _z		F _{Rd}		allow. F _z		F _{Rd}		allow. q _z		q _{Rd}		allow. q _z		q _{Rd}		allow. q _z		q _{Rd}			
1.00 m		1.00 m		2.00 m		2.00 m		3.00 m		3.00 m		1.00 m		1.00 m		2.00 m		2.00 m		3.00 m		1.00 m		1.00 m		3.00 m			
7.3	10.2	3.7	5.2	2.4	3.4	5.5	7.7	2.8	3.9	1.6	2.2	14.7	20.6	3.7	5.2	1.5	2.1												
4.5	6.3	2.2	3.1	1.3	1.8	3.4	4.8	1.7	2.4	0.8	1.1	9	12.6	2.2	3.1	0.7	1.0												

allow. F _z		F _{Rd}		allow. F _z		F _{Rd}		allow. F _z		F _{Rd}		allow. F _z		F _{Rd}		allow. q _z		q _{Rd}		allow. q _z		q _{Rd}		allow. q _z		q _{Rd}			
0.50 m		0.50 m		1.00 m		1.00 m		1.50 m		1.50 m		0.50 m		0.50 m		1.00 m		1.00 m		1.50 m		0.50 m		0.50 m		1.00 m		1.50 m	
3.20	4.48	1.60	2.24	1.10	1.54	2.40	3.36	1.20	1.68	0.60	0.84	12.90	18.06	3.20	4.48	1.20	1.68												
1.50	2.10	0.80	1.12	0.40	0.56	1.10	1.54	0.50	0.70	0.23	0.32	6.10	8.54	1.40	1.96	0.40	0.56												
0.70	0.98	0.22	0.31	0.10	0.14	0.50	0.70	0.13	0.18	0.06	0.08	2.70	3.78	0.30	0.42	0.10	0.14												
0.90	1.26	0.40	0.56	0.22	0.31	0.70	0.98	0.30	0.42	0.13	0.18	3.50	4.90	0.80	1.12	0.23	0.32												
0.23	0.32	0.06	0.08	0.03	0.04	0.14	0.20	0.04	0.06	0.02	0.03	0.80	1.12	0.10	0.14	0.03	0.04												

- ① Observe minimum distance a_e between channel end and load point (HALFEN Bolt, locking plate):
heavy and medium duty framing systems: $a_e \geq 30$ mm,
light duty framing systems: $a_e \geq 20$ mm.
- ② Do not exceed the bolt load capacity or the max. channel load bearing capacity.
- ③ For maximum point-load capacity:
 $F_z = \max$, load bearing capacity of the channel lips.
- ④ Take constructive measures to prevent failure caused by bulging, tilting and buckling.
- ⑤ On request.

All load capacities were calculated using the elastic-plastic method acc. to EN 1993-1, partial safety factor $\gamma_F = 1.4$; deflection $\leq l / 150$.
 Determination of the allowable value
allow. $F_z = F_{Rd} / 1.4$.

Note: For stainless steel framing channels the bending deflection value must be verified separately using the valid E-modulus of elasticity.

HALFEN FRAMING SYSTEMS

Load Bearing Capacities for Welded or Bolted HALFEN Framing Channels

Hot-rolled framing channels welded or bolted to structural elements

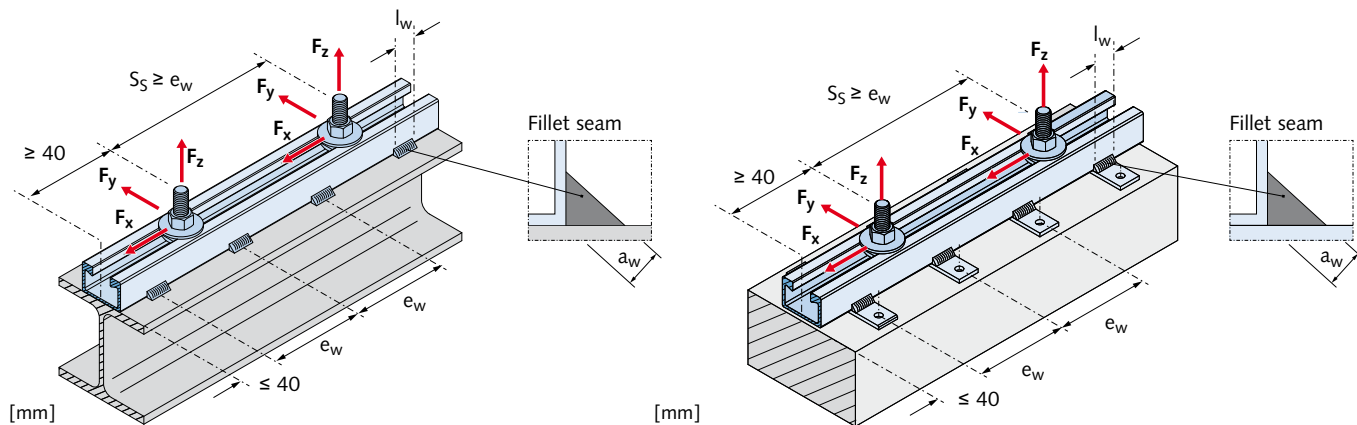

Load bearing capacities for welded or bolted hot-rolled framing channels

Profile	Weld seams			Point-load bearing capacity ⑤						HALFEN Bolts	
	aw [mm]	lw [mm]	ew [mm]	allowable load F① [kN]			Design values of resistance FRd① [kN]			Bolt size	Spacing
				allow. Fz	allow. Fy	allow. Fx	Fz,Rd	Fy,Rd	Fx,Rd	diam. [mm]	Ss
Hot-rolled											
HM 72/48	5	50	300	47.0	10.8 ④	②	65.8	15.2 ④	②	M24	Ss ≥ ew
HM 55/42	4	30	250	38.6	17.2		54.0	24.0		M20	
HM 52/34	4	30	200	25.9	14.9	36.3	20.9	M20			
HM 50/30	4	30	200	14.4	10.0	20.2	14.0	M20			
HM 40/22	3	30	150	8.2	4.7	11.4	6.6	M16			
HZM 64/44	5	40	250	38.1	12.5	27.0	53.3	17.4	37.8	M24	
HZM 53/34	4	30	200	30.9	9.3	22.0/19.0 ③	43.3	13.1	30.8/26.6 ③	M20	
HZM 41/27	4	30	200	17.8	4.4	12.0	25.0	6.2	16.8	M16	
HZM 38/23	4	30	200	12.8	4.2	12.0	18.0	5.9	16.8	M16	
HZM 29/20	3	30	150	8.0	1.5	8.0	11.2	2.0	11.2	M12	

② Recommended load bearing capacities in channel longitudinal direction for standard (non-serrated) channels can be found on the dedicated product page

③ For stainless steel

④ For this determined value, failure of the A4 bolt is decisive

① In case of simultaneous loading in all directions the following criterion must be met:

$$\frac{F_z}{\text{allow. } F_z} + \frac{F_y}{\text{allow. } F_y} + \frac{F_x}{\text{allow. } F_x} \leq 1$$

resp.

$$\frac{F_{z,Ed}}{F_{z,Rd}} + \frac{F_{y,Ed}}{F_{y,Rd}} + \frac{F_{x,Ed}}{F_{x,Rd}} \leq 1$$

F_x, F_y, F_z = existing load;
allow. F = allowable point-load capacity

resp.

F_{x,Ed}, F_{y,Ed}, F_{z,Ed} = Design values of action;

F_{x,Rd}, F_{y,Rd}, F_{z,Rd} = Design values of resistance

⑤ The bearing capacities are for loads acting on the front edge of the channel. For off-set transverse load (e.g. stand-off installations) the bending moment of the bolt must be considered and superimposed with the tensile load, see page 69.

HALFEN FRAMING SYSTEMS

Load Bearing Capacities for Welded or Bolted HALFEN Framing Channels

Framing channels welded or bolted to structural elements

Allowable point-load capacities for HM Channels

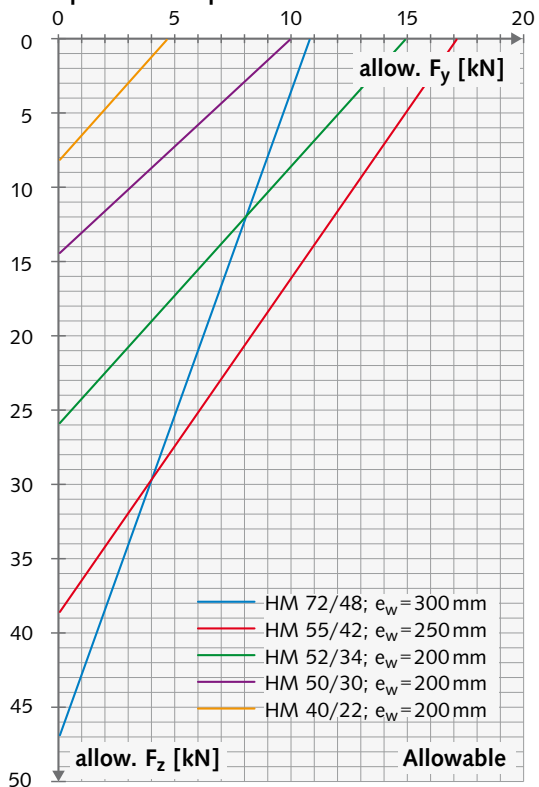

Design point-load for HM Channels

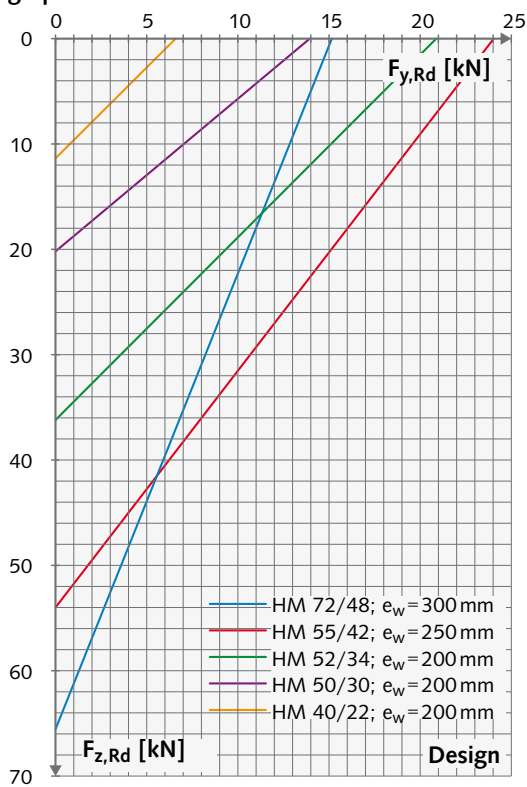

Allowable point-load capacities for HZM Channels

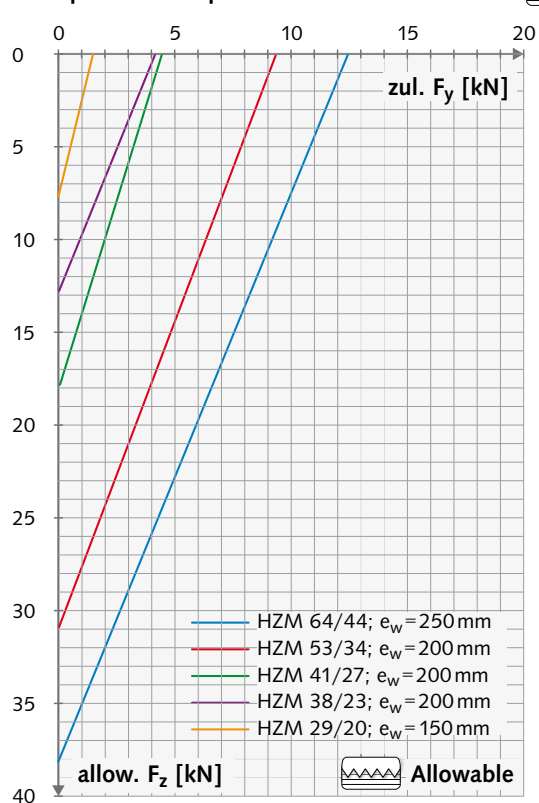

Design point-load for HZM Channels

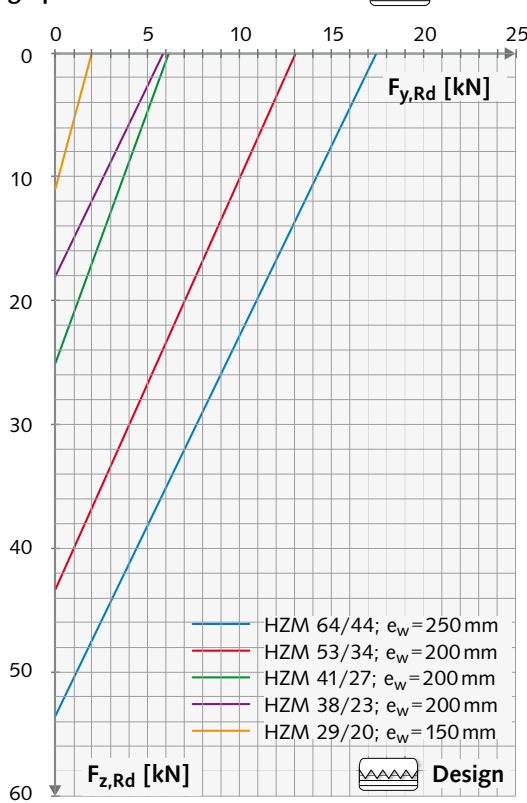

HALFEN FRAMING SYSTEMS

Load Capacities for Welded or Bolted HALFEN Framing Channels

Cold-rolled framing channels welded or bolted to structural elements

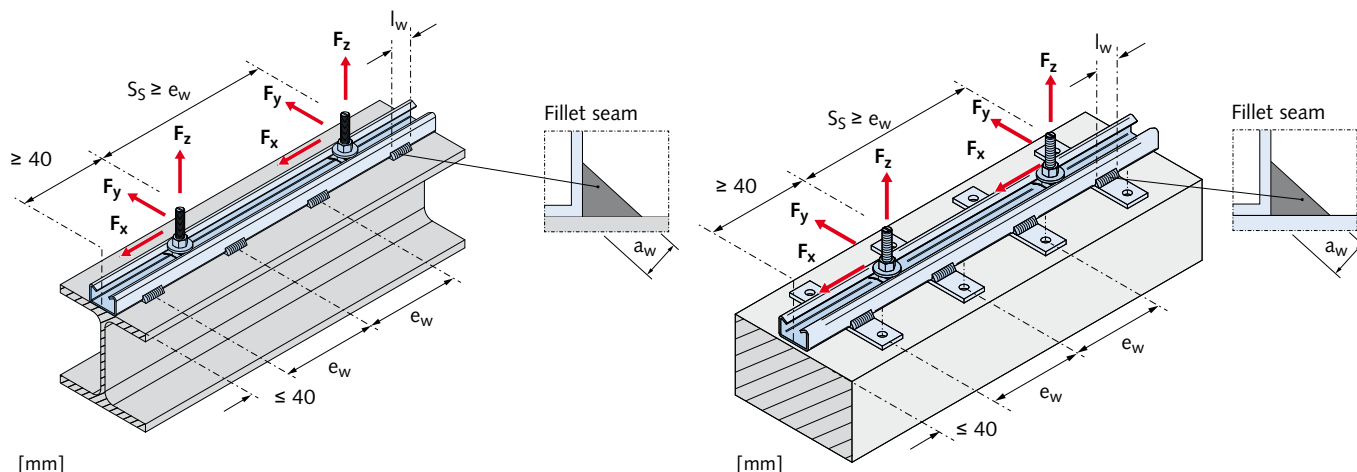

Load bearing capacities for welded or bolted cold-rolled framing channels

Cold-rolled	<p>Tension area $\alpha \leq 60^\circ$ Transverse tension area $\gamma < 60^\circ$</p>	Profil	Weld seams			Point-load bearing capacities ②					
			a_w [mm]	l_w [mm]	e_w [mm]	Tension $\alpha \leq 60^\circ$ F_z [kN]		Transverse tension $\gamma < 60^\circ$ F_y [kN]		Longitudinal tension F_x [kN]	
						allow. F_z	$F_{z,Rd}$	allow. F_y	$F_{y,Rd}$	allow. F_x	$F_{x,Rd}$
HM 50/40	3	30	400	5.4	7.6	1.9	2.7	①	①		
HZM 41/41	3	30	300	5.6	7.8	1.2	1.7	5.0	7.0		
HZM 41/22	3	30	120	5.6	7.8	1.5	2.1	5.0	7.0		
HM 41/41	3	30	300	5.6	7.8	1.2	1.7				
HM 41/22	3	30	120	5.6	7.8	1.5	2.1				
HM 36/36	3	30	300	4.4	6.2	1.2	1.7	①	①		
HM 38/17	3	30	100	4.8	6.7	2.5	3.5				
HM 28/15	3	30	100	2.5	3.5	1.2	1.7				

① Recommended load bearing capacities in channel longitudinal direction for standard (non-serrated) channels can be found on the dedicated product page

② The bearing capacities are for loads acting on the front edge of the channel. For off-set transverse load (e.g. stand-off installations) the bending moment of the bolt must be considered and superimposed with the tensile stress, see page 69.

HALFEN FRAMING SYSTEMS

HALFEN Bolts – Bending moments

Bending moments of HALFEN Bolts

Bending moments of HALFEN Bolts

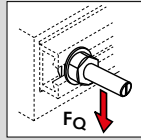

Recommended bolt bending moments from the front edge of the HALFEN Channel

Strength class

Thread Ø	4.6		8.8		A2-50; A4-50		A2-70; A4-70	
	allow. M	M _{Rd} ①	allow. M	M _{Rd} ①	allow. M	M _{Rd} ①	allow. M	M _{Rd} ①
M6	2.0	2.8	-	-	1.8	2.5	3.8	5.3
M8	5.0	7.0	-	-	4.4	6.2	9.4	13.2
M10	10.0	14.0	24.9	34.9	8.7	12.2	18.7	26.2
M12	17.5	24.5	43.7 ^②	61.2 ^②	15.3	21.4	32.8 ^②	45.9 ^②
M16	44.4	62.2	111.0 ^③	155.4 ^③	38.8	54.3	83.3 ^③	116.6 ^③
M20	86.5	121.1	216.4	303.0	75.7	106.0	162.3	227.2
M24	149.7	209.4	374.2	524.0	131.1	183.3	156.2	218.7
M27	221.9	310.7	554.8	776.7	-	-	-	-
M30	299.9	419.9	-	-	-	-	-	-

① Recommended design value of bending moment capability for HALFEN Bolts

② For profile HM/HL 28/15 bending moment must be reduced to M_{Rd} = 42 Nm resp. allow. M = 30 Nm

③ For profile HM/HL 38/17 bending moment must be reduced to M_{Rd} = 91 Nm resp. allow. M = 65 Nm

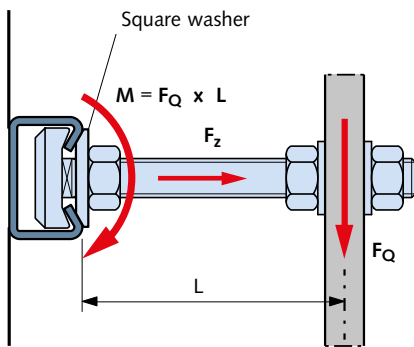

A square washer must always be used with stand-off installations.

In cases of bending with additional centric tension the action loads must be superimposed with the tensile load.



$$F_z \leq \text{allow. } F \cdot \left(1 - \frac{M}{\text{allow. } M} \right)$$

resp.

$$F_{z,Ed} \leq F_{Rd} \cdot \left(1 - \frac{M_{Ed}}{M_{Rd}} \right)$$

F_z = existing tension load
 allow. F_z = allowable load bearing capacity of the bolt
 M = existing bending moment of the bolt
 allow. M = allowable bending moment of the bolt
 resp.

F_{z,Ed} = Design value for the existing tension load of the bolt

F_{z,Rd} = Design value for the resistance of the bolt

M_{Ed} = Design value for the existing bending moment of the bolt

M_{Rd} = Design value for bending moment resistance of the bolt

HALFEN FRAMING SYSTEMS

Framing Channels as Compression Elements

HALFEN Framing channels as compression element – hot-rolled

Flexural buckling acc. to EN 1993-1-1
(Point-load applied at P)

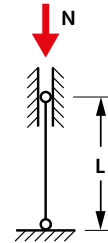
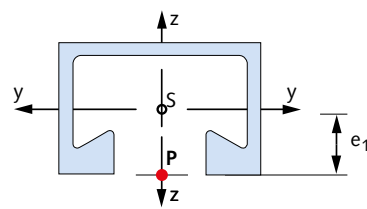
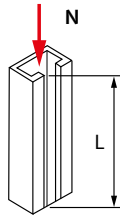

Table footnotes → see page 71

Load bearing capacities – flexural buckling

Type	Cross-section properties					N [kN] ①,② for element length L [mm]										
	A [cm ²]	e ₁ [cm]	I _y [cm ⁴]	W _y [cm ³]	W _{pl} [cm ³]	500	1000	1500	2000	2500	3000	3500	4000	4500	5000	
	[kN]															
HM 72/48	11.27	2.40	34.97	14.28	18.28	N _{Rd}	104.6	81.6	62.0	50.0	40.0	32.2	26.4	21.8	18.4	15.6
						allow. N	74.7	58.3	44.3	35.7	28.6	23.0	18.9	15.6	13.1	11.1
HM 55/42	8.61	2.21	18.75	8.49	11.73	N _{Rd}	79.0	57.5	43.0	32.8	25.1	19.8	15.8	12.9	10.7	9.0
						allow. N	56.4	41.1	30.7	23.4	17.9	14.1	11.3	9.2	7.6	6.4
HM 52/34	6.34	1.74	9.33	5.35	7.19	N _{Rd}	50.4	34.6	25.3	18.5	13.9	10.7	8.5	6.8	5.6	4.7
						allow. N	36.0	24.7	18.1	13.2	9.9	7.6	6.1	4.9	4.0	3.4
HM 50/30	4.15	1.63	5.26	3.23	4.38	N _{Rd}	31.8	21.4	15.3	11.0	8.2	6.3	4.9	4.0	3.2	2.7
						allow. N	22.7	15.3	10.9	7.9	5.8	4.5	3.5	2.8	2.3	1.9
HM 40/22	2.70	1.25	1.99	1.59	2.17	N _{Rd}	18.2	11.2	7.3	5.0	3.5	2.6	-	-	-	-
						allow. N	13.0	8.0	5.2	3.5	2.5	1.9	-	-	-	-
HM 72/48 D	22.54	4.85	205.15	42.30	55.20	N _{Rd}	195.2	169.2	148.0	128.0	110.0	98.0	87.0	77.0	68.5	61.0
						allow. N	139.4	120.9	105.7	91.4	78.6	70.0	62.1	55.0	48.9	43.6
HM 55/42 D	17.22	4.20	105.70	25.17	34.27	N _{Rd}	155.0	130.0	109.0	90.0	78.0	67.0	57.5	46.3	43.0	37.5
						allow. N	110.7	92.9	77.9	64.3	55.7	47.9	41.1	33.1	30.7	26.8
HM 52/34 D	12.70	3.35	51.49	15.37	20.42	N _{Rd}	97.0	80.0	64.5	53.5	45.0	37.5	31.8	26.9	23.1	20.0
						allow. N	69.3	57.1	46.1	38.2	32.1	26.8	22.7	19.2	16.5	14.3
HM 50/30 D	8.27	3.00	26.56	8.85	11.52	N _{Rd}	61.5	49.0	38.5	31.7	26.0	21.5	17.9	15.0	12.8	11.0
						allow. N	43.9	35.0	27.5	22.6	18.6	15.4	12.8	10.7	9.1	7.9
HM 40/22 D	5.33	2.30	10.06	4.38	5.73	N _{Rd}	37.0	27.5	20.9	16.1	12.6	10.0	8.1	6.7	5.6	4.7
						allow. N	26.4	19.6	14.9	11.5	9.0	7.1	5.8	4.8	4.0	3.4
HZM 64/44	9.10	2.30	23.83	10.36	13.66	N _{Rd}	91.0	68.0	51.0	39.5	30.5	24.3	19.5	16.0	13.3	11.2
						allow. N	65.0	48.6	36.4	28.2	21.8	17.4	13.9	11.4	9.5	8.0
HZM 53/34	5.88	1.86	9.19	4.95	6.80	N _{Rd}	51.8	35.0	25.5	18.5	13.9	10.6	8.4	6.8	5.6	4.7
						allow. N	37.0	25.0	18.2	13.2	9.9	7.6	6.0	4.8	4.0	3.3
HZM 41/27	4.31	1.51	3.90	2.57	3.74	N _{Rd}	31.5	20.0	13.2	9.2	6.7	5.0	3.9	3.1	2.5	-
						allow. N	22.5	14.3	9.4	6.6	4.8	3.6	2.8	2.2	1.8	-
HZM 38/23	3.10	1.33	2.11	1.59	2.31	N _{Rd}	20.7	12.5	7.9	5.3	3.8	2.8	2.2	-	-	-
						allow. N	14.8	8.9	5.6	3.8	2.7	2.0	1.6	-	-	-
HZM 29/20	1.99	1.12	1.02	0.91	1.31	N _{Rd}	12.5	7.1	4.3	2.8	-	-	-	-	-	-
						allow. N	8.9	5.1	3.1	2.0	-	-	-	-	-	-
HZM 64/44 D	18.21	4.40	127.94	29.08	38.23	N _{Rd}	171.0	144.5	122.0	102.0	88.5	76.5	66.0	57.5	50.0	43.9
						allow. N	122.1	103.2	87.1	72.9	63.2	54.6	47.1	41.1	35.7	31.4
HZM 53/34 D	11.75	3.40	46.38	13.64	18.14	N _{Rd}	100.0	81.0	63.5	53.0	43.5	36.3	30.3	25.5	21.7	18.8
						allow. N	71.4	57.9	45.4	37.9	31.1	25.9	21.6	18.2	15.5	13.4
HZM 41/27 D	8.62	2.70	19.91	7.37	10.22	N _{Rd}	65.5	49.5	38.0	29.8	23.5	18.9	15.3	12.7	10.6	9.0
						allow. N	46.8	35.4	27.1	21.3	16.8	13.5	10.9	9.1	7.6	6.4
HZM 38/23 D	6.19	2.30	10.04	4.36	6.00	N _{Rd}	43.6	30.9	23.4	17.5	13.5	10.6	8.5	6.9	5.8	4.9
						allow. N	31.1	22.1	16.7	12.5	9.6	7.6	6.1	4.9	4.1	3.5
HZM 29/20 D	3.97	2.00	5.12	2.56	3.49	N _{Rd}	27.9	19.1	13.8	10.0	7.6	5.9	4.6	3.8	3.1	2.6
						allow. N	19.9	13.6	9.9	7.1	5.4	4.2	3.3	2.7	2.2	1.8

HALFEN FRAMING SYSTEMS

Framing Channels as Compression Elements

HALFEN Framing channels as compression elements – cold-rolled

Flexural buckling acc to. EN 1993-1-1
(Point-load applied at P)

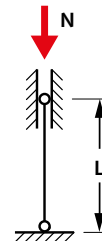
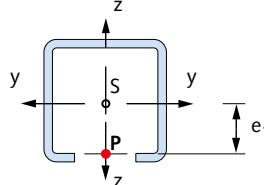
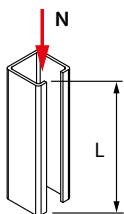

Load bearing capacities – Flexural buckling

Type	Cross-section properties					N [kN] ①,② for element length L [mm]													
	A [cm ²]	e ₁ [cm]	I _y [cm ⁴]	W _y [cm ³]	W _{pl} [cm ³]	500	1000	1500	2000	2500	3000	3500	4000	4500	5000				
	[kN]																		
HM 50/40	4.26	2.18	8.64	3.96	5.53	N _{Rd}	33.2	24.6	18.5	14.2	11.1	8.8	7.0	5.8	4.8	4.1			
						allow. N	23.7	17.6	13.2	10.1	7.9	6.3	5.0	4.1	3.5	2.9			
HM 41/41	3.40	2.31	7.47	3.24	4.57	N _{Rd}	26.3	19.7	15.0	11.7	9.2	7.3	6.0	4.9	4.1	3.5			
						allow. N	18.8	14.1	10.7	8.4	6.6	5.2	4.3	3.5	2.9	2.5			
HM 36/36	2.80	2.07	4.54	2.19	3.19	N _{Rd}	19.7	14.1	10.6	8.0	6.1	4.8	3.9	3.2	2.6	2.2			
						allow. N	14.1	10.1	7.5	5.7	4.4	3.4	2.8	2.3	1.9	1.6			
HM 28/28	1.73	1.58	1.70	1.08	1.54	N _{Rd}	11.4	7.5	5.2	3.7	2.7	-	-	-	-	-			
						allow. N	8.1	5.4	3.7	2.6	2.0	-	-	-	-	-			
HM 26/26	1.05	1.48	0.95	0.64	0.90	N _{Rd}	7.0	4.5	3.1	-	-	-	-	-	-	-			
						allow. N	5.0	3.2	2.2	-	-	-	-	-	-	-			
HZM 41/41	3.36	2.33	7.34	3.15	4.48	N _{Rd}	25.5	19.3	14.6	11.4	9.0	7.2	5.8	4.8	4.0	3.4			
						allow. N	18.2	13.8	10.4	8.1	6.4	5.1	4.1	3.4	2.9	2.4			
HZM 41/41 D	6.71	4.13	36.45	8.83	12.09	N _{Rd}	49.0	41.5	35.0	29.1	25.3	21.8	18.8	16.3	14.2	12.5			
						allow. N	35.0	29.6	25.0	20.8	18.1	15.6	13.4	11.6	10.1	8.9			
HL 50/40	3.73	1.95	7.14	3.65	4.68	N _{Rd}	31.5	22.8	16.9	12.8	9.8	7.7	6.1	5.0	4.1	3.5			
						allow. N	22.5	16.3	12.1	9.1	7.0	5.5	4.4	3.6	2.9	2.5			
HL 41/41	2.98	2.14	6.07	2.84	3.82	N _{Rd}	23.8	17.5	13.2	10.1	7.9	6.2	5.0	4.1	3.4	2.9			
						allow. N	17.0	12.5	9.4	7.2	5.6	4.4	3.6	2.9	2.4	2.0			
HL 36/36	2.42	1.85	3.65	1.97	2.64	N _{Rd}	18.3	12.7	9.4	7.0	5.3	4.1	3.2	2.6	-	-			
						allow. N	13.1	9.1	6.7	5.0	3.8	2.9	2.3	1.9	-	-			
HL 28/28	1.48	1.39	1.33	0.95	1.25	N _{Rd}	10.4	6.7	4.5	3.1	2.3	-	-	-	-	-			
						allow. N	7.4	4.8	3.2	2.2	1.6	-	-	-	-	-			
HL 26/26	0.89	1.29	0.73	0.56	0.72	N _{Rd}	6.3	3.9	2.6	-	-	-	-	-	-	-			
						allow. N	4.5	2.8	1.9	-	-	-	-	-	-	-			
HZL 63/63 ③	7.09	3.01	33.07	10.06	13.51	N _{Rd}	65.0	53.2	43.3	35.4	29.7	24.8	20.9	17.7	15.2	13.1			
						allow. N	46.4	38.0	30.9	25.3	21.2	17.7	14.9	12.6	10.9	9.4			
HZL 41/41	2.90	2.18	5.87	2.69	3.70	N _{Rd}	22.5	16.7	12.6	9.7	7.5	6.0	4.8	4.0	3.3	2.8			
						allow. N	16.1	11.9	9.0	6.9	5.4	4.3	3.4	2.8	2.3	2.0			

① N_{Rd} = Design value of resistance
allow. N = allowable load

② allow. N = N_{Rd} / 1.4; E = 170 000 N/mm²

③ allow. N = N_{Rd} / 1.4; E = 210 000 N/mm²

Note:

For higher excentricity "e > e₁" a flexural buckling analysis acc. to Eurocode 3 is necessary.

HALFEN FRAMING SYSTEMS

Applications in Mechanical Engineering and Industrial Plant Construction

Information on dimensioning

When designing an adjustable assembly system the external load F_i must be less or equal to the minimum permissible load of the bolt F_s and to the maximum point-load capacity and respectively to the bending load capacity of the HALFEN Framing channel F_z .
 $F_i \leq \text{MIN} (F_s; F_z)$ (→ see page 50)
 $F_i \leq \text{MIN} (F_{\text{Bolt}}; F_{\text{Channel}})$; $F_{\text{Channel}} \rightarrow$ see page 60 ff.

Design value of the resistance: $F_{R,d} = 1.4 \times F$ (Forces)

Design value of the moment resistance: $M_{R,d} = 1.4 \times M$ (Moments)

All following load specifications are allowable loads.

Symbols and definitions used for mechanical engineering – steel construction industry

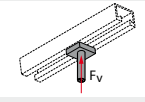
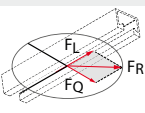
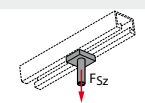
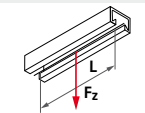
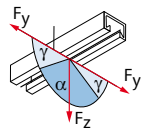
HALFEN Bolts	F_v		Preloading force, bolt The preloading force of the bolt occurs by applying a torque on the bolt and is calculated according to VDI 2230 guidelines.
	F_R		Resulting force The resulting force F_R is the vector addition of the external loads F_L in the longitudinal channel direction and the external load F_Q transverse to the longitudinal channel direction; the resulting force is frictionally connected to the channel. $F_R = \sqrt{(F_L^2 + F_Q^2)}$
	F_{sz}		Force in the longitudinal bolt direction The force F_{sz} is an external load through the screws longitudinal axis, perpendicular to the channel surface and is transferred positive-locked to the channel.
HALFEN Framing channels	F_z		Maximum point-load-carrying capacity – centric load The load carrying capacity of the channel lips is decisive. Load figures are only valid for continuous welded channels or intermittent welds according to the table on page 66 ff. In all other cases the suitability of the welding seam must be checked.
	F_y		Load capacity of the channels under transverse load angle $\gamma < 60^\circ$ Permissible load for a defined angle to the welded or bolted channels.
	F_z		Load capacity of the channels under transverse load angle $\alpha \leq 60^\circ$ Permissible load for a defined load angle to the welded or bolted channels.

The force F_{sz} along the screw longitudinal axis must be less or equal to the maximum point-load capacity of the framing channel F_z .

$$F_{sz} \leq F_z$$

The force F_Q transverse to the longitudinal channel direction must be less or equal to the load capacity transverse to the longitudinal channel direction of the framing channel F_y .

$$F_Q \leq F_y$$

HALFEN FRAMING SYSTEMS

Applications in Mechanical Engineering and Industrial Plant Construction

Required bolt length L_{bolt}

The required bolt length L_{bolt} is the sum of the clamp thickness KD and the minimum required supplement L_{sup} .

$$L_{bolt} = KD + L_{sup}$$

$$L_{sup} = h + m + v$$

The thread protrusion v has to extend pass the nut at least $0.5 \times$ the nut height m (DIN EN 24032 regulation for nuts).

Minimum required supplement L_{sup}
according to the table below

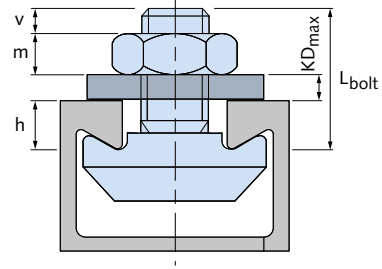

Minimum required supplement for HALFEN Bolts (heavy duty framing systems) [mm]

Thread	HM 72/48	HM 55/42	HM 52/34	HM 50/30	HM 49/30	HM 40/22	HM 40/25	HM 422	HZM 64/44	HZM 53/34	HZM 41/27	HZM 38/23	HZM 29/20	HM 50/40	HM 486
M6	-	-	-	-	-	-	-	-	-	-	-	-	-	-	-
M8	-	-	-	-	-	-	-	-	-	-	-	-	12	-	-
M10	-	25	24	20	20	18	18	18	-	-	18	17	15	-	-
M12	-	29	27	24	23	22	22	22	-	-	21	21	16	19	18
M16	-	35	33	30	29	28	28	28	-	28	27	27	20	23	22
M20	42	39	38	34	34	-	-	-	34	32	-	-	-	29	28
M24	47	-	-	-	-	-	-	-	40	-	-	-	-	33	32
M27	50	-	-	-	-	-	-	-	-	-	-	-	-	-	-
M30	53	-	-	-	-	-	-	-	-	-	-	-	-	-	-

Minimum required supplement for HALFEN Bolts (medium duty framing systems) [mm]

Thread	HZL 63/63	HM 41/41	HM 41/22	HM 41/62	HM 41/83	HLL 41/41	HLL 41/22
M6	-	-	-	-	-	-	-
M8	-	18	18	18	18	18	18
M10	-	19	19	19	19	19	19
M12	19	23	23	23	23	23	23
M16	23	29	29	29	29	29	29
M20	29	-	-	-	-	-	-
M24	33	-	-	-	-	-	-

Minimum required supplement for HALFEN Bolts (light duty framing systems) [mm]

Thread	HM 36/36	HM 38/17	HM 28/28	HM 26/26	HM 28/15	HM 315	HM 20/12
M6	-	-	-	-	-	-	-
M8	-	-	10	9	10	9	9
M10	15	15	13	12	13	12	12
M12	18	19	14	13	14	14	-
M16	24	25	18	17	18	17	-

HALFEN FRAMING SYSTEMS

Applications in Mechanical Engineering and Industrial Plant Construction

Static and dynamic tension tests

The transferability of static and dynamic loads for adjustable assembly systems was intensely studied in cooperation with the State Material Testing Institute at the TU Darmstadt (Technical University Darmstadt).

Following VDI guideline 2230, the data acquired from bolt tightening tests, static and dynamic traction tests form the basis of algorithms used for calculating adjustable assembly systems.

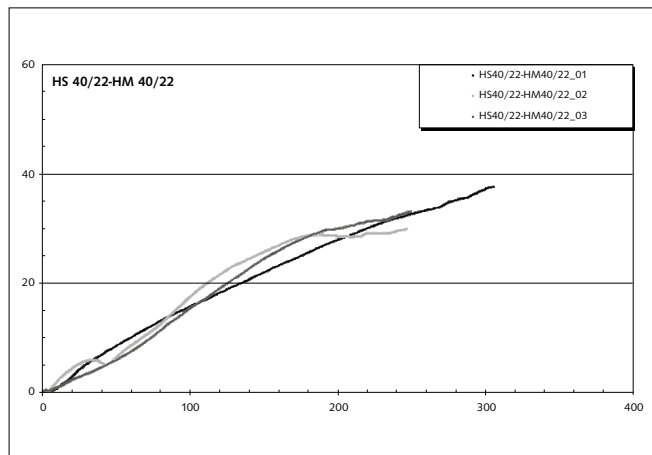

Graph; tightening test results

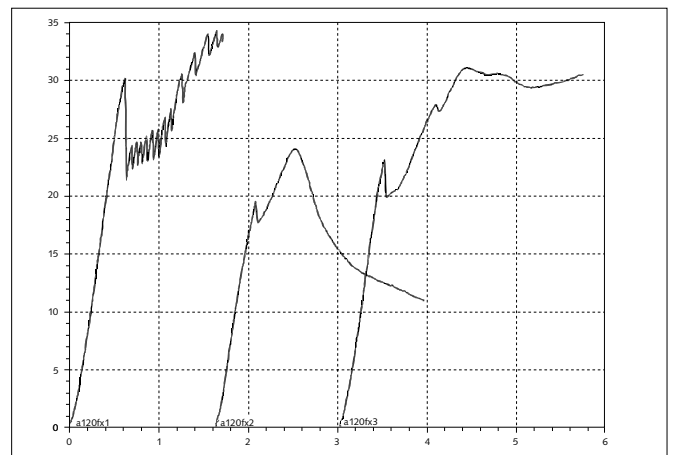

Graph, tension test results

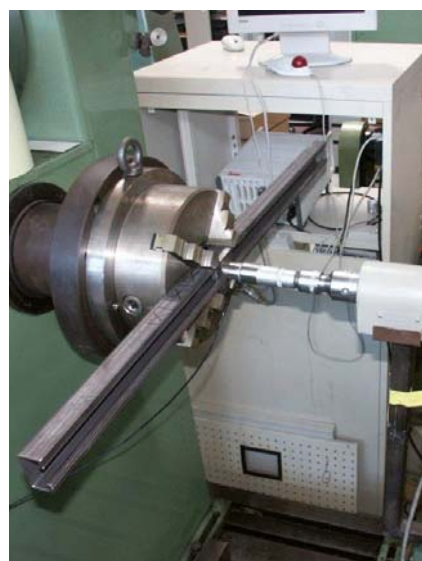

Tightening test



Tension test



Fatigue test

Framing Channels
Heavy Duty Framing Systems
Medium Duty Framing Systems
Light Duty Framing Systems
Accessories
Statics
Mechanical engineering

HALFEN FRAMING SYSTEMS

Applications in Mechanical Engineering and Industrial Plant Construction

Generating the preloading force F_V

During assembly of bolt connections the torque M_A induces a preloading force F_V in the bolt, which results in clamping the component to the framing channel. The preloading force F_V depends on the torque M_A , the friction coefficients μ_G of the bolt thread and μ_K on the nut contact surface.

The preloading forces for stainless steel bolts 50/70 and for HALFEN Bolts in steel, strength class 4.6 and 8.8 are specified in the following tables (ref. Rohloff-Matek).

The data listed for the torque M_A are recommended values. Standard delivery condition for HALFEN Bolts is non-lubricated, installation ready.

The friction coefficients μ_G and μ_K are 0.24.

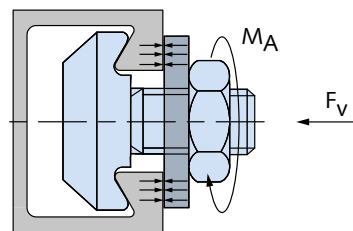

Preload force F_V , strength class 4.6 [kN]

	M_A [Nm]	Friction coefficient $\mu_G = \mu_K$												
		0.12	0.14	0.16	0.18	0.20	0.22	0.24	0.26	0.28	0.30	0.32	0.34	0.36
M6	3	3.0	2.6	2.3	2.1	1.9	1.8	1.6	1.5	1.4	1.3	1.2	1.2	1.1
M8	8	6.1	5.3	4.7	4.3	3.9	3.5	3.3	3.0	2.8	2.7	2.5	2.4	2.2
M10	15	9.2	8.0	7.1	6.4	5.8	5.3	4.9	4.6	4.3	4.0	3.8	3.6	3.4
M12	25	12.9	11.3	10.0	9.0	8.2	7.5	6.9	6.4	6.0	5.6	5.3	5.0	4.7
M16	65	25.6	22.3	19.8	17.8	16.1	14.8	13.6	12.6	11.8	11.0	10.4	9.8	9.2
M20	130	40.8	35.6	31.6	28.4	25.7	23.6	21.7	20.1	18.8	17.6	16.5	15.6	14.8
M24	230	60.5	52.8	46.8	42.0	38.2	34.9	32.2	29.9	27.8	26.1	24.5	23.1	21.9
M27	340	79.8	69.5	61.5	55.2	50.0	45.8	42.1	39.1	36.4	34.1	32.0	30.2	28.6
M30	460	96.7	84.2	74.6	67.0	60.7	55.6	51.2	47.5	44.2	41.4	38.9	36.7	34.8

Preload force F_V , strength class 8.8 [kN]

	M_A [Nm]	Friction coefficient $\mu_G = \mu_K$												
		0.12	0.14	0.16	0.18	0.20	0.22	0.24	0.26	0.28	0.30	0.32	0.34	0.36
M8	20	15.2	13.3	11.8	10.6	9.7	8.9	8.2	7.6	7.1	6.6	6.2	5.9	5.6
M10	40	24.4	21.4	19.0	17.1	15.5	14.2	13.1	12.2	11.4	10.7	10.0	9.5	9.0
M12	70	36.1	31.6	28.1	25.2	22.9	21.0	19.4	18.0	16.8	15.7	14.8	14.0	13.2
M16	180	70.8	61.8	54.8	49.2	44.6	40.9	37.7	34.9	32.6	30.5	28.7	27.1	25.6
M20	360	113.1	98.6	87.5	78.5	71.3	65.2	60.1	55.8	52.0	48.7	45.8	43.2	40.9
M24	620	163.1	142.3	126.2	113.3	102.8	94.1	86.8	80.5	75.0	70.3	66.1	62.3	59.0
M27	900	211.2	183.9	162.8	146.1	132.5	121.1	111.6	103.5	96.4	90.2	84.8	80.0	75.7
M30	1200	252.1	219.7	194.7	174.7	158.5	145.0	133.6	123.8	115.4	108.1	101.6	95.8	90.7

Preload force F_V , strength class 50

	M_A [Nm]	Friction coefficient $\mu_G = \mu_K$												
		0.12	0.14	0.16	0.18	0.20	0.22	0.24	0.26	0.28	0.30	0.32	0.34	0.36
M6	3	3.0	2.6	2.3	2.1	1.9	1.8	1.6	1.5	1.4	1.3	1.2	1.2	1.1
M8	7	5.3	4.6	4.1	3.7	3.4	3.1	2.9	2.7	2.5	2.3	2.2	2.1	2.0
M10	14	8.6	7.5	6.7	6.0	5.4	5.0	4.6	4.3	4.0	3.7	3.5	3.3	3.1
M12	25	12.9	11.3	10.0	9.0	8.2	7.5	6.9	6.4	6.0	5.6	5.3	5.0	4.7
M16	60	23.6	20.6	18.3	16.4	14.9	13.6	12.6	11.6	10.9	10.2	9.6	9.0	8.5
M20	120	37.7	32.9	29.2	26.2	23.8	21.7	20.0	18.6	17.3	16.2	15.3	14.4	13.6
M24	200	52.6	45.9	40.7	36.6	33.2	30.4	28.0	26.0	24.2	22.7	21.3	20.1	19.0

Preload force F_V , strength class 70

	M_A [Nm]	Friction coefficient $\mu_G = \mu_K$												
		0.12	0.14	0.16	0.18	0.20	0.22	0.24	0.26	0.28	0.30	0.32	0.34	0.36
M6	7	7.0	6.2	5.5	4.9	4.5	4.1	3.8	3.5	3.3	3.1	2.9	2.7	2.6
M8	15	11.4	10.0	8.9	8.0	7.2	6.6	6.1	5.7	5.3	5.0	4.7	4.4	4.2
M10	30	18.3	16.0	14.3	12.8	11.7	10.7	9.9	9.2	8.5	8.0	7.5	7.1	6.7
M12	50	25.8	22.6	20.0	18.0	16.4	15.0	13.8	12.9	12.0	11.2	10.6	10.0	9.4
M16	125	49.2	42.9	38.0	34.2	31.0	28.4	26.2	24.3	22.6	21.2	19.9	18.8	17.8
M20	245	76.9	67.1	59.5	53.5	48.5	44.4	40.9	38.0	35.4	33.1	31.2	29.4	27.8
M24	420	110.5	96.4	85.5	76.8	69.7	63.8	58.8	54.5	50.8	47.6	44.8	42.2	40.0

HALFEN FRAMING SYSTEMS

Applications in Mechanical Engineering and Industrial Plant Construction

Transfer of static loads

External loads F_L , F_Q and F_{S_z} acting on the building component are transferred to the bolt connection by clamping.

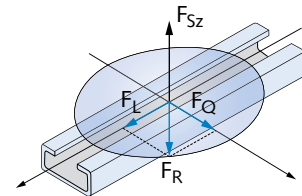

Force F_{S_z} acts positively in the bolt longitudinal axis.

Force F_L acting in and F_Q acting transverse to the longitudinal channel direction are transferred through the component-channel surface frictionally and are added to the resulting force F_R :

$$F_R = \sqrt{F_L^2 + F_Q^2}$$

Transfer of the friction force F_R requires a normal force F_N acting in the bolt longitudinal axis:

$$F_N = \frac{F_R}{\mu_T}$$

The minimum required clamping force $F_{K,req}$ is a result of the two forces F_N and F_{S_z} acting in the bolt longitudinal axis:

$$F_{K,req} = F_N + F_{S_z} = \frac{F_R}{\mu_T} + F_{S_z}$$

When designing the bolt connection the bolt tightening procedure and the bolt setting behavior must be considered in accordance with VDI guideline 2230. The setting factor S_{set} is intended as a safety factor because the setting force loss for adjustable bolt connections is difficult to calculate using VDI 2230. Therefore the minimum necessary assembly preloading strength $F_{M, min}$ is:

$$F_{M, min} = S_{set} \times F_{K, req}$$

Taking the bolt tightening procedure into consideration with the tightening factor α_A the maximum necessary assembly preloading force $F_{M, max}$ calculates at:

$$F_{M, max} = \alpha_A \times F_{M, min} = \alpha_A \times S_{set} \times \left(\frac{F_R}{\mu_T} + F_{S_z} \right)$$

The maximum required assembly preloading force $F_{M, max}$ must be smaller than the preloading force F_V produced by the bolt tightening procedure moment M_A :

$$F_{M, max} \leq F_V$$

The permissible loads for channel assembly systems are shown as for **delivery condition** ($\mu_G = \mu_K = 0.24$) and for **lubricated bolts** ($\mu_G = \mu_K = 0.14$) in the tables on page 77.

The values for F_R apply only to transverse force requirements ($F_{S_z} = 0$), the values for F_{S_z} for pure traction force requirement ($F_R = 0$).

When overlaying the transverse force F_R and longitudinal force F_{S_z} apply the formulas listed right for the maximum assembly preloading force $F_{M, max}$.

Framing Channels
 Heavy Duty Framing Systems
 Medium Duty Framing Systems
 Light Duty Framing Systems
 Accessories
 Statics
 Mechanical engineering

HALFEN FRAMING SYSTEMS

Applications in Mechanical Engineering and Industrial Plant Construction

Allowable loads F_R and F_{S_z} - channel bolt connection								
Strength class 4.6								
Thread	M_A [Nm]	Delivery condition $\mu_G = \mu_K = 0.24$			Lubricated $\mu_G = \mu_K = 0.14$			F_Z [kN]
		F_V [kN]	F_R [kN]	F_Z [kN]	F_V [kN]	F_R [kN]	F_Z [kN]	
M6	3	1.6	0.2	0.7	2.6	0.3	1.1	
M8	8	3.3	0.3	1.4	5.3	0.6	2.2	
M10	15	4.9	0.5	2.1	8.0	0.8	3.3	
M12	25	6.9	0.7	2.9	11.3	1.2	4.7	
M16	65	13.6	1.4	5.7	22.3	2.3	9.3	
M20	130	21.7	2.3	9.0	35.6	3.7	14.8	
M24	230	32.2	3.4	13.4	52.8	5.5	22.0	
M27	340	42.1	4.4	17.6	69.5	7.2	28.9	
M30	460	51.2	5.3	21.3	84.2	8.8	35.1	

Allowable loads F_R and F_{S_z} - channel bolt connection								
Strength class 8.8								
Thread	M_A [Nm]	Delivery condition $\mu_G = \mu_K = 0.24$			Lubricated $\mu_G = \mu_K = 0.14$			F_Z [kN]
		F_V [kN]	F_R [kN]	F_Z [kN]	F_V [kN]	F_R [kN]	F_Z [kN]	
M10	40	13.1	1.4	5.5	21.4	2.2	8.9	
M12	70	19.4	2.0	8.1	31.6	3.3	13.2	
M16	180	37.7	3.9	15.7	61.8	6.4	25.7	
M20	360	60.1	6.3	25.1	98.6	10.3	41.1	
M24	620	86.8	9.0	36.2	142.3	14.8	59.3	
M27	900	111.6	11.6	46.5	183.9	19.2	76.6	

Allowable loads F_R and F_{S_z} - channel bolt connection								
Strength class 50								
Thread	M_A [Nm]	Delivery condition $\mu_G = \mu_K = 0.24$			Lubricated $\mu_G = \mu_K = 0.14$			F_Z [kN]
		F_V [kN]	F_R [kN]	F_Z [kN]	F_V [kN]	F_R [kN]	F_Z [kN]	
M8	7	2.9	0.3	1.4	4.6	0.6	2.2	
M10	14	4.6	0.5	2.1	7.5	0.8	3.4	
M12	25	6.9	0.7	2.9	11.3	1.2	4.7	
M16	60	12.6	1.3	5.3	20.6	2.2	8.6	
M20	120	20.0	2.1	8.4	32.9	3.4	13.8	
M24	200	28.0	2.9	11.7	45.9	4.8	19.2	

Allowable loads F_R and F_{S_z} - channel bolt connection								
Strength class 70								
Thread	M_A [Nm]	Delivery condition $\mu_G = \mu_K = 0.24$			Lubricated $\mu_G = \mu_K = 0.14$			F_Z [kN]
		F_V [kN]	F_R [kN]	F_Z [kN]	F_V [kN]	F_R [kN]	F_Z [kN]	
M8	15	6.1	0.6	2.6	10.0	1.0	4.2	
M10	30	9.9	1.0	4.1	16.0	1.7	6.7	
M12	50	13.8	0.9	5.8	22.6	1.4	9.4	
M16	125	26.2	2.7	10.9	42.9	4.5	17.9	
M20	245	40.9	4.3	17.1	67.1	7.0	28.0	
M24	420	58.8	6.1	24.5	96.4	10.0	40.2	

The given data is based on the following failure modes and values:

- Failure mode for transverse force load F_R : component slippage
- Failure mode for longitudinal force load F_{S_z} : component separation
- Friction coefficient in connection: $\mu_T = 0.25$
- Tightening factor (electrical-audible torque wrench): $\alpha_A = 2.0$
- Safety factor setting of bolt connection: $S_{set} = 1.2$

The force F_Q transverse to the longitudinal channel direction must be smaller or equal to the load capacity transverse to the longitudinal channel direction of the HALFEN Framing channel F_y (→ see table on page 78).

$$F_Q \leq F_y$$

The force in the longitudinal bolt direction F_{S_z} must be smaller or equal to the maximum point-load capacity of the HALFEN Framing channel F_z (→ see table on page 78).

$$F_{S_z} \leq F_z$$

HALFEN FRAMING SYSTEMS

Applications in Mechanical Engineering and Industrial Plant Construction

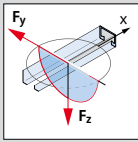
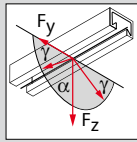
Point-load capacity of the HALFEN Framing channel							
Point-load capacities for hot-rolled, welded or bolted HALFEN Framing channels				Point-load capacities for cold-rolled, welded or bolted HALFEN Framing channels			
							
	Profile	allow. F_z [kN]	allow. F_y [kN]	Profile	tension $\alpha \leq 60^\circ$ allow. F_z [kN]	transverse tension $\gamma < 60^\circ$ allow. F_y [kN]	
Hot-rolled	HM 72/48	47.0	10.8	Cold-rolled	HM 50/40	5.4	1.9
	HM 55/42	38.6	17.2		HZM 41/41	5.6	1.2
	HM 52/34	25.9	14.9		HZM 41/22	5.6	1.5
	HM 50/30	14.4	10.0		HM 41/41	5.6	1.2
	HM 40/22	8.2	4.7		HM 41/22	5.6	1.5
	HZM 64/44	38.1	12.5		HM 36/36	4.4	1.2
	HZM 53/34	30.9	9.3		HM 38/17	4.8	2.5
	HZM 41/27	17.8	4.4		HM 28/15	2.5	1.2
	HZM 38/23	12.8	4.2		-	-	-
HZM 29/20	8.0	1.5	-	-	-		

The table notes on pages 66 and 68 must be observed!

Example:

Specified:	external load in longitudinal channel direction	$F_L = 1.5 \text{ kN}$
	external load transverse to the longitudinal channel direction	$F_Q = 0.5 \text{ kN}$
	external load in longitudinal bolt direction	$F_{S_z} = 2.0 \text{ kN}$
	friction between component – channel	$\mu_T = 0.25$
	setting factor	$S_{set} = 1.2$
	tightening factor	$\alpha_A = 2$

Selected framing channel HM 50/30

Resulting load F_R	1.58 kN
Minimum required assembly preloading force $F_{M \min}$	10 kN
Maximum required assembly preloading force $F_{M \max}$	20 kN

Selected HALFEN Bolt 50/30, 4.6 in delivery condition	M 20
Preloading F_v	21.7 kN

Comparison of external loads with permissible load of channel HM 50/30 with values in table above

$$F_z = 14.4 \text{ kN} > F_{S_z} \quad \checkmark$$

$$F_y = 10.0 \text{ kN} > F_Q \quad \checkmark$$

Result:

Selected framing channel: HM 50/30
Selected HALFEN Bolt: HS 50/30 – M20 - scl. 4.6 in standard delivery condition

HALFEN FRAMING SYSTEMS

Applications in Mechanical Engineering, Machine Construction and Industrial Plant Construction

Transfer of dynamic loads

Hot-rolled assembly channels are suitable for the transfer of dynamic loads when used in conjunction with nibbed HALFEN Bolts (type HSR) or serrated HALFEN Bolts (type HZS).

The dynamic load $F_{L\ dyn}$ acting on the building component in the longitudinal channel direction, is transferred frictionally via the channel/bolt contact surface to the channel.

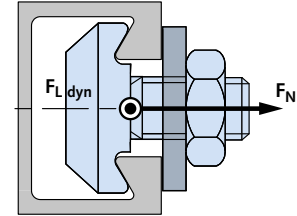

A clamping force $F_{K\ req}$ acting in the bolt longitudinal axis is necessary for friction transfer $F_{L\ dyn}$:

$$F_{K\ req} = \frac{F_{L\ dyn}}{\mu_T}$$

According to VDI guideline 2230 when designing the bolt connection, the bolt tightening procedure and the bolt setting behavior must be considered. The setting factor S_{set} is intended as a safety factor because the setting force loss for adjustable bolt connections is difficult to calculate using VDI 2230.

$$F_{M\ min} = S_{set} \times F_{K\ req}$$

Therefore the minimum necessary assembly preloading strength $F_{M\ min}$ is:

Taking the bolt tightening procedure into consideration with the tightening factor α_A the maximum necessary assembly preloading force $F_{M\ max}$ is calculated at:

$$F_{M\ max} = \alpha_A \times S_{set} \times \frac{F_{L\ dyn}}{\mu_T}$$

The calculated maximum assembly preloading force $F_{M\ max}$ must be smaller or equal to the preloading force F_V of the bolt (see table):

$$F_{M\ max} \leq F_V$$

The permissible dynamic loads for channel assembly systems are shown as for **delivery condition** ($\mu_G = \mu_K = 0.24$) and for a lubricated condition ($\mu_G = \mu_K = 0.14$) in the following table.

The values are valid for **pure alternating stress with a transverse force in the longitudinal channel direction**.

The stress ratio is $R = -1$ and the maximum load changes value is $N = 10^6$.

Allowable dynamic loads $F_{L\ dyn}$ – channel-bolt connection							
HALFEN Bolts HSR and HZS, strength class 8.8							
		Delivery condition			Lubricated		
		$\mu_G = \mu_K = 0.24$			$\mu_G = \mu_K = 0.14$		
Thread	M_A [Nm]	F_V [kN]	$F_{L\ dyn}$ [kN]	Typ	F_V [kN]	$F_{L\ dyn}$ [kN]	Type
M12	80	22.3	2.3	HZS	36.2	3.8	HZS
M16	120	25.2	2.6	HZS	41.3	4.3	HZS
M16	200	42.1	4.4	HSR	68.8	7.2	HSR
M20	400	67.2	7.0	HSR	109.9	11.4	HSR

This data is based on the following failure modes and values:

Failure mode for transverse force load $F_{L\ dyn}$: component slippage

Friction coefficient in connection: $\mu_T = 0.25$

Tightening factor (electrical-audible torque wrench): $\alpha_A = 2.0$

Safety factor setting of bolt joint: $S_{set} = 1.2$

Individual calculation of bolted connections is achieved using the formulas and tables listed above.

HALFEN FRAMING SYSTEMS

Invitation to tender

Invitation to tender – examples for HALFEN Framing channels and cantilevers

HM 52/34 - black steel - 6070

HALFEN - Framing channel HM 52/34 profile, hot-rolled, black steel, with CE-marking in accordance with DIN EN 1090, for the flexible linking of framing constructions using system-compliant HALFEN Bolt connections.

Required framing channel length pursuant to structural requirements.

Nominal profile dimensions (width x height): 52 mm x 34 mm

Length (mm):

- 6.070

- Fixed length (fixed length surcharge)

Deliver, cut to the required extent (if not fixed length) and assemble.

Please note information provided by the manufacturer regarding assembly and use.

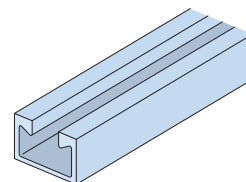

HM 50/30 - HDG - 6070

HALFEN - Framing channel HM 50/30 profile, hot-rolled, hot-dip galvanised (hdg), with CE-marking in accordance with DIN EN 1090, for the flexible linking of framing constructions using system-compliant HALFEN Bolt connections.

Required framing channel length pursuant to structural requirements.

Nominal profile dimensions (width x height): 50 mm x 30 mm

Length (mm):

- 6.070

- Fixed length (fixed length surcharge)

Deliver, cut to the required extent (if not fixed length) and assemble.

Please note information provided by the manufacturer regarding assembly and use.

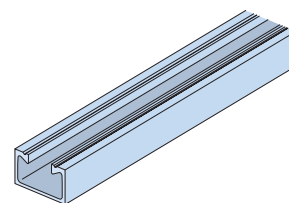

HZM 53/34 - A4 - 6070

HALFEN - Framing channel HZM 53/34 profile, hot-rolled and toothed, A4, with CE-marking in accordance with DIN EN 1090, for the flexible linking of framing constructions using system-compliant HALFEN Bolt connections.

Required framing channel length pursuant to structural requirements.

Nominal profile dimensions (width x height): 53 mm x 34 mm

Length (mm):

- 6.070

- Fixed length (fixed length surcharge)

Deliver, cut to the required extent (if not fixed length) and assemble.

Please note information provided by the manufacturer regarding assembly and use.

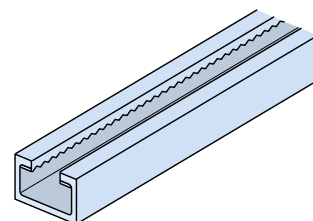

HALFEN Cantilever KON 36/2, hot-dip galvanised

HALFEN - cantilever, KON 36/2, hot-dip galvanised (hdg), with CE-marking in accordance with DIN EN 1090, for the flexible linking of framing constructions using system-compliant HALFEN Bolt connections.

Required cantilever length pursuant to structural requirements.

Length (mm):

Deliver and assemble.

Please note information provided by the manufacturer regarding assembly and use.

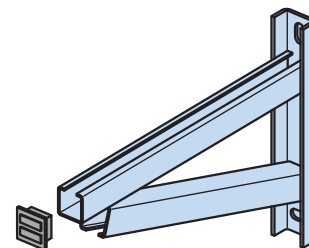

Further tender specifications at : [www.halfen.de/Service/Tender texts](http://www.halfen.de/Service/Tender%20texts)

HALFEN POWERCLICK SYSTEM

The Innovation in Pipeline Construction

The multi-functional system for any project

POWERCLICK SYSTEM 63



Suitable for pipes with nominal diameters up to DN 150 mm or with separate verification up to 400 mm
→ Catalogue PC 63

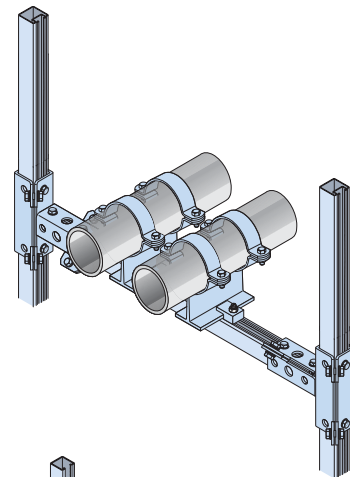

POWERCLICK SYSTEM 41



Suitable for pipes with nominal diameters up to 80 mm or with short spans up to 150 mm with separate verifications
→ Catalogue PC 41

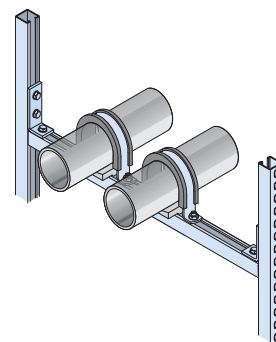

POWERCLICK SYSTEM 22



Suitable for pipes with nominal diameters up to 25 mm
→ Catalogue PC Z

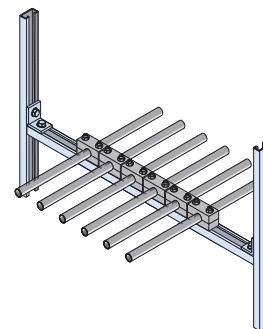

POWERCLICK ACCESSORIES

Cantilever brackets, pipe clamps, sliding supports
→ Catalogue PC Z



Product information on the internet. Catalogues and tender texts available at: halfen.de/Products/Powerclick. Or simply scan the code, select the required document and download the PDF.



HALFEN FRAMING SYSTEMS

Index

Product/keyword	Page
Accessories	56 - 57
Adjustment coupler HJV	57
Bending load bearing capacities - framing channels	60 - 65
Bending moments HALFEN Bolts	69
Bolt length - determination	8
Bolts	7, 54, 55
Cantilevers KON	59
Cap for channel ends HPE	58
CE-marking	4
Channel cover PA	58
Channel end cap	58
Compression elements	70 - 71
Coupler sleeves VBM, SKM	57
Coupler sleeves with right-hand left-hand thread	57
Dynamic loads	79
European standards	4
Flexural buckling - framing channels	70 - 71
Framing channels - type overview	6, 12, 13
-non slotted HM, HZM hot-rolled	60 - 61
-non slotted HM, HZM cold-rolled	62 - 63
-with slot hole HL, HZL	64 - 65
Geometry - slot holes and spacings	64
HALFEN Bolts type HS, HZS, HSR	7
HALFEN Cast-in channels for installation in concrete	5
HALFEN Framing channels - product overview	12-13
Hexagonal Bolts HSK	57
Hexagonal coupler sleeves	57
Hexagonal nuts MU	56

Product/keyword	Page
Load capacities framing channels	60 - 71
Locking plates	8
Locking washers SIC	56
Materials	10-10
Nuts MU	56
Ordering examples	8
Point-load capacity	66 - 68
Powerclick	39, 81
Preloading force	75
Product range - Framing channels	12-13
Product range - HALFEN Bolts	54 - 55
Ring nuts RM	57
Serrated cast in channels	5
Square washer VUS	56
Stainless steel profiles - overview	12-13
Stand-off installation	69
Tender texts	80
Threaded rods GWS	57
Toothed channels = serrated channels	6, 12, 13
Turnbuckles with right- and left-hand sleeves	57
Verification method - explanation	4
Washers	44

CONTACT HALFEN WORLDWIDE

HALFEN is represented by subsidiaries in the following countries, please contact us!

Austria	HALFEN Gesellschaft m.b.H. Leonard-Bernstein-Str. 10 1220 Wien	Phone: +43-1-259 6770 E-Mail: office@halfen.at Internet: www.halfen.at	Fax: +43-1-259-677099
Belgium / Luxembourg	HALFEN N.V. Borkelstraat 131 2900 Schoten	Phone: +32-3-658 07 20 E-Mail: info@halfen.be Internet: www.halfen.be	Fax: +32-3-658 15 33
China	HALFEN Construction Accessories Distribution Co.Ltd. Room 601 Tower D, Vantone Centre No. A6 Chao Yang Men Wai Street Chaoyang District Beijing · P.R. China 100020	Phone: +86-10 5907 3200 E-Mail: info@halfen.cn Internet: www.halfen.cn	Fax: +86-10 5907 3218
Czech Republic	HALFEN s.r.o. Business Center Šafránkova Šafránkova 1238/1 155 00 Praha 5	Phone: +420-311-690 060 E-Mail: info@halfen.cz Internet: www.halfen.cz	Fax: +420-235-314 308
France	HALFEN S.A.S. 18, rue Goubet 75019 Paris	Phone: +33-1-445231 00 E-Mail: halfen@halfen.fr Internet: www.halfen.fr	Fax: +33-1-445231 52
Germany	HALFEN Vertriebsgesellschaft mbH Liebigstr. 14 40764 Langenfeld	Phone: +49-2173-970-0 E-Mail: info@halfen.de Internet: www.halfen.de	Fax: +49-2173-970 225
Italy	HALFEN S.r.l. Soc. Unipersonale Via F.lli Bronzetti N° 28 24124 Bergamo	Phone: +39-035-0760711 E-Mail: tecnico@halfen.it Internet: www.halfen.it	Fax: +39-035-0760799
Netherlands	HALFEN b.v. Oostermaat 3 7623 CS Borne	Phone: +31-74-267 14 49 E-Mail: info@halfen.nl Internet: www.halfen.nl	Fax: +31-74-267 26 59
Norway	HALFEN AS Postboks 2080 4095 Stavanger	Phone: +47-51 82 34 00 E-Mail: post@halfen.no Internet: www.halfen.no	Fax: +47-51 82 34 01
Poland	HALFEN Sp. z o.o. Ul. Obornicka 287 60-691 Poznan	Phone: +48-61-622 14 14 E-Mail: info@halfen.pl Internet: www.halfen.pl	Fax: +48-61-622 14 15
Spain	HALFEN Spain PLAKABETON S.L. Polígono Industrial Santa Ana c/ Ignacio Zuloaga 20 28522 Rivas-Vaciamadrid	Phone: +34 916 669 181 E-Mail: info@halfen.es Internet: www.halfen.es	Fax: +34 916 669 661
Sweden	Halfen AB Vädursgatan 5 412 50 Göteborg	Phone: +46-31-98 58 00 E-Mail: info@halfen.se Internet: www.halfen.se	Fax: +46-31-98 58 01
Switzerland	HALFEN Swiss AG Hertistrasse 25 8304 Wallisellen	Phone: +41-44-849 78 78 E-Mail: info@halfen.ch Internet: www.halfen.ch	Fax: +41-44-849 78 79
United Kingdom / Ireland	HALFEN Ltd. A1/A2 Portland Close Houghton Regis LU5 5AW	Phone: +44-1582-47 03 00 E-Mail: info@halfen.co.uk Internet: www.halfen.co.uk	Fax: +44-1582-47 03 04
United States of America	HALFEN USA Inc. PO Box 18687 San Antonio TX 78218	Phone: +1 800.423.91 40 E-Mail: info@halfenusa.com Internet: www.halfenusa.com	Fax: +1 877.683.4910
For countries not listed HALFEN International	HALFEN International GmbH Liebigstr. 14 40764 Langenfeld / Germany	Phone: +49-2173-970-0 E-Mail: info@halfen.com Internet: www.halfen.com	Fax: +49-2173-970-849

NOTES REGARDING THIS CATALOGUE

Technical and design changes reserved. The information in this publication is based on state-of-the-art technology at the time of publication. We reserve the right to make technical and design changes at any time. HALFEN GmbH shall not accept liability for the accuracy of the information in this publication or for any printing errors.

The HALFEN GmbH subsidiaries in Germany, France, the Netherlands, Austria, Poland, Switzerland and the Czech Republic are Quality Management certified according to **ISO 9001:2015**, Certificate no. 202384-2016-AQ-GER-DAkKS.





For further information please contact: www.halfen.com